

**NOISE RADIATION FROM WIND TURBINES INSTALLED NEAR HOMES:
EFFECTS ON HEALTH**

With an annotated review of the research and related issues

By Barbara J Frey, BA, MA and Peter J Hadden, BSc, FRICS

February 2007

June 2007

www.windturbينوnoisehealthhumanrights.com

NOISE RADIATION FROM WIND TURBINES INSTALLED NEAR HOMES: EFFECTS ON HEALTH

With an annotated review of the research and related issues

By Barbara J Frey, BA, MA and Peter J Hadden, BSc, FRICS

Contents

1.0	Abstract
2.0	Introduction
3.0	Overview of the Problems: Personal Perspectives
4.0	Acoustics
5.0	Health Effects
6.0	Human Rights
7.0	Conclusions
	References
	Appendix: Property Values
	Acknowledgements

Note: This paper limits its discussion to wind turbines taller than 50m or from 0.75MW up to 2MW installed capacity.

Section 1.0 ABSTRACT

Wind turbines are large industrial structures that create obtrusive environmental noise pollution when built too close to dwellings. This annotated review of evidence and research by experts considers the impact of industrial-scale wind turbines suffered by those living nearby. First, the paper includes the comments by some of the families affected by wind turbines, as well as coverage in news media internationally. The experiences described put a human face to the science of acoustics.

Second, the paper reviews research articles within the field of acoustics concerning the acoustic properties of wind turbines and noise. The acoustic characteristics of wind turbines are complex and in combination produce acoustic radiation. Next, the paper reviews the health effects that may result from the acoustic radiation caused by wind turbines, as well as the health effects from noise, because the symptoms parallel one another. Primarily, the consequent health response includes sleep deprivation and the problems that ensue as a result. In addition, this paper reviews articles that report research about the body's response not only to the audible noise, but also to the inaudible components of noise that can adversely affect the body's physiology. Research points to a causal link between unwanted sound and sleep deprivation and stress, i.e., whole body physiologic responses.

These injuries are considered in the context of Human Rights, where it is contended that the environmental noise pollution destroys a person's effective enjoyment of right to respect for home and private life, a violation of Article 8 of the European Court of Human Rights Act. Furthermore, the paper considers the consequent devaluation of a dwelling as a measure of part of the damage that arises when wind turbines are sited too close to a dwelling, causing acoustic radiation and consequent adverse health responses.

The review concludes that a safe buffer zone of at least 2km should exist between family dwellings and industrial wind turbines of up to 2MW installed capacity, with greater separation for a wind turbine greater than 2MW installed capacity.

Section 2.0 INTRODUCTION

- 1 Industrial wind turbines produce an intermittent flow of electricity but in the process also produce undesirable noise emissions when installed too close to people's homes, causing environmental noise pollution. (See Section 6.5 of this paper.)
- 2 Wind turbines located at a sensible distance from dwellings are unlikely to cause environmental noise pollution and health problems. When the State allows priority to commercial interests, the reasonable needs of families and their human rights are extinguished. There are questions of human rights and of industrial and governmental ethics when developers construct wind turbines too close to dwellings, especially when Government decision makers are fully aware that there is a high probability that families may lose the right of respect for their home and private life. In such instances, both the commercial groups and the State are party to the violation.
- 3 This Review seeks to bring together research evidence in the professional literature that addresses the substantive nature of the problem, both from the acoustical and biomedical perspectives. However, the Review would be incomplete without Section 3, Overview of the Problems – Personal Perspectives, which includes the observations and reflections by those living near wind turbines, as well as reports in the media. The Review also considers the possible infringement of human rights when developers build wind turbines in close proximity to dwellings.
- 4 Precision in predicting noise levels in homes neighbouring wind turbines has so far eluded the wind industry. As early as 1987, Glegg, Baxter, and Glendinning reported on the problems with predicting noise accurately:

'This paper describes a broadband noise prediction scheme for wind turbines. The source mechanisms included in the method are unsteady lift noise, unsteady thickness noise, trailing edge noise and the noise from separated flow ... [In] spite of these detailed predictions of the atmospheric boundary layer the noise predictions are 10dB below the measured levels ... [The upwind] support tower cannot be ignored, since significant acoustic scattering occurs when the rotor blade is close to the tower. This can be very important subjectively and so a theoretical model has been developed which allows for the increase in radiation due to this effect.' [Glegg SAL, Baxter SM, and Glendinning AG. The prediction of broadband noise from wind turbines. Journal of sound and vibration 1987; 118(2): 217-39, pp 217-218]

- 5 In a recent (2006) Report the Dti found further studies of wind turbine noise were necessary:

'However, the presence of aerodynamic modulation which is greater than that originally foreseen by the authors of ETSU-R-97, particularly during the night hours, can result in internal wind farm noise levels which are audible and which may provoke an adverse reaction from a listener ... To take account of periods when aerodynamic modulation is a clearly audible feature within the incident noise, it is recommended that a means to assess and apply a correction the incident noise is developed.' [Dti Executive

Summary of the Measurement of Low Frequency Noise at Three UK Wind Farms, contract number W/45/00656/00/00, URN number 06/1412, Contractor: Hayes McKenzie Partnership Ltd, 2006.]

The report states that ‘... *it may be appropriate to re-visit the issue of aerodynamic modulation and a means by which it should be assessed.*’
[p 65]

6 The wind energy industry and its consultants – acoustical engineers – claim that the audible and inaudible noise effects have minimal consequence on humans and that infrasound (0Hz – 20Hz, part of the low frequency noise spectrum), is inaudible and weak and therefore not a human health risk. This review has not found any epidemiological evidence to support these suppositions.

7 As more wind turbines are installed near homes, more communities are affected by these complex sounds. Noise is the human face of the science of sound, and physicians are seeing the results. More people living close to wind turbines – within 1.5km – complain of sleep deprivation, headaches, dizziness, unsteadiness, nausea, exhaustion, mood problems, and inability to concentrate.

Physicians and researchers in the UK, Portugal, Germany, the USA, Australia, and New Zealand, among others, have observed a similar constellation of symptoms.

8 Although acousticians and engineers working for the wind energy industry conclude that audible noise and low frequency noise from wind turbines are unlikely to cause health effects, experts in biomedical research have drawn different conclusions.

9 Indeed, in 2006, the French National Academy of Medicine issued a report that concludes:

‘The harmful effects of sound related wind turbines are insufficiently assessed ... People living near the towers, the heights of which vary from 10 to 100 meters, sometimes complain of functional disturbances similar to those observed in syndromes of chronic sound trauma ... The sounds emitted by the blades being low frequency, which therefore travel easily and vary according to the wind, ... constitute a permanent risk for the people exposed to them ... An investigation conducted by the Ddass [Direction Departementale des Affaires Sanitaires et Sociales] in Saint-Crepin (Charent-Maritime) revealed that sound levels 1 km from an installation occasionally exceeded allowable limits.’

The report continues:

‘While waiting for precise studies of the risks connected with these installations, the Academy recommend halting wind turbine construction closer than 1.5 km from residences.’

[Chouard C-H. Le retentissement du fonctionnement des eoliennes sur la sante de l’homme (Repercussions of wind turbine operations on human health). Panorama du Medecin, 20 March 2006]

- 10 Warning signs of future problems with new technologies have been overlooked or ignored in the past, much to the detriment of the public's health. One has only to look at the history of asbestos and mesothelioma; tobacco and lung cancer and chronic pulmonary diseases; thalidomide and birth defects; mercury and neurotoxicity; x-rays and fluoroscopes and cancer; lead-based paint and childhood poisoning; and coal miners and black lung, to name but a few. The pattern of medical problems took time to emerge before a pattern of health complaints were observed, followed by epidemiologic studies and public health policy.
- 11 Human health effects may take years to emerge as a pattern, when the detrimental effects are past correction. As the numbers of wind turbine installations close to people's homes increase, reports of health effects have escalated, from sites across the globe. These problems do not appear to be present where wind turbines are located at a safe distance from homes.
- 12 This paper brings together research evidence on the characteristics of noise radiated by wind turbines and how that noise affects human health. As this is a public health issue, this paper also presents the advice and policy recommendations of medical and epidemiological experts.

This paper also considers whether as a result of reported health problems, the noise emission components of wind turbines should be regarded as an environmental noise pollution, which is a violation of basic Human Rights.

Section 3.0 OVERVIEW OF THE PROBLEMS: Personal Perspectives

‘Britain should be considerably quieter than it is ... unless something is done the situation will soon become intolerable.’ [The Times, London, 3 July 1963]

1 This section of the paper, perhaps more than any other, illustrates that noise is the human face of the science of acoustics. This section presents that essential – but often ignored – side of the equation: the voices of those directly affected by the construction of wind turbines near their homes.

2 In 1966, Dr Alan Bell observed that noise is much more than an occupational hazard:

‘Noise is a sensory input, devoid of information, that nevertheless demands attention ... it is a public nuisance and a danger to mental and physical health ... The degree of annoyance is not necessarily directly related to the intensity of the sound ... The factors influencing community responses included lack of sleep ... The results of past lack of forethought are aggravated by situations still developing that will certainly create noise problems in years to come ... Even rural peace is often shattered.’ [Bell, A. Noise: an occupational hazard and public nuisance. Geneva: World Health Organization, 1966.]

3 Both the European and British Wind Energy Associations, in their Best Practice Guidelines, state that:

‘Wind turbines should not be located so close to domestic dwellings that they unreasonably affect the amenity of such properties through noise, shadow flicker, visual dominance or reflected light.’

4 But these are only industry guidelines. Planning Policy Statement 22, section 22, says that:

‘Renewable technologies may generate small increases in noise levels (whether from machinery such as aerodynamic noise from wind turbines, or from associated sources – for example, traffic).

Local planning authorities should ensure that renewable energy developments have been located and designed in such a way to minimise increases in ambient noise levels.

Plans may include criteria that set out the minimum separation distances between different types of renewable energy projects and existing developments. The 1997 report by ETSU [ETSU-R-97, The assessment and rating of noise from wind farms] for the Dti should be used to assess and rate noise from wind energy development.’

5 This guidance is scrupulously followed by wind turbine developers and Planning decision makers. Section 4.0 of this paper, Acoustics, addresses the limitations of ETSU-R-97; yet it is interesting to note here that the standards in ETSU-R-97 appear to provide less protection to people than the standards of the World Health Organisation *Guidelines for Community Noise 1999*.

- 6 ETSU-R-97 and subsequent policies based on that document fail to protect families living near wind turbines, as the following illustrates:

For a fortnight beginning 12 January 2004, complainants and witnesses gave evidence about their experiences living near the Askam, Cumbria, UK, wind turbines. These wind turbines are rather modest compared to the larger turbines of today: seven wind turbines, each 62.5m high.

Prior to the construction, the developers had assured the community that wind turbines near their homes would not create noise or visual disturbances. Background noise prior to the wind farm was as low as 16.5 dB, with a nighttime average of about 19 dB. The readings are now regularly in the middle to high 40's dB.

'Eventually the developers admitted everything that we had claimed – but still nothing has been done to resolve these problems to the satisfaction of those people who matter.' [Brierley D., *Public Presentation, Askam, Cumbria, 2006*]

- 7 On seeking assistance from the local Council, the Askam residents were then informed that *'because of the court case of **Gillingham v Medway Council**, the classification of the area had changed with the passing of the planning permission'*. That is, the area where the wind turbines were built had been reclassified as a mixed rural/industrial area; local residents were unaware of this reclassification.

Consequently, their expectations of noise levels were considered *'unrealistically high'* for an industrialised area, according to the local authority. [Brierley, 2006]

- 8 Indeed, when the Askam residents brought a case against the developer PowerGen (E.ON), the judge eventually ruled against the residents, saying that ***"audibility and annoyance are not to be equated with nuisance."*** [Brierley D., *Public Presentation, Askam, Cumbria, 2006*]

- 9 The following are excerpts of statements of only a few who have lived near wind turbine installations. Some of these families have consequently moved home because they felt it impossible to enjoy a normal family life by remaining.

It is important to remember that some of these statements were written or presented several years after living with the daily, or nearly daily, intrusions of noise and/or shadow flicker / strobing caused by wind turbines.

Please note: In respect for the residents' confidentiality, the authors are identifying the families by number rather than by name.

- 10 *'Everything changed ... when the wind turbines arrived ...approximately 700 metres away from our property ... At this point we had no idea how this development (windfarm) was to effect [sic] our quality of life and cause so much pain and suffering. Within days of the windfarm coming into operation we began to hear a terrible noise, but didn't know, at first, where it was coming from. As it continued we eventually realised the noise originated from the windfarm. We were horrified. Were we the only ones suffering this noise?'*

Would this continue for the proposed length of time the windfarm would be there i.e. for the next 20 years? The noise drove us mad. Gave us headaches. Kept us awake at night. Prevented us from having windows and doors open in hot weather, and was extremely disturbing.'

Member of Family 01

Some time after the wind turbines began operation, this resident learned that other people were experiencing the same problems; they attempted to voice their concerns and their distress:

'From that day, until the present, despite telephone calls, letters to, (and liaison meetings with), the owner, the operators, representatives of the Parish Council, the District Council, the local Planning Committee, the Environmental Health Department and our member of Parliament ... nothing has been resolved.'

- 11 On one occasion, several of the wind turbines were switched off on the morning of one bank holiday, to give this family some relief (this is 4 years on ...), but by evening, the turbines were operational, and the noise returned. This resident's statement continues with an anecdote: one of the wind turbine operators who lived several kilometres from the site said

'... quite openly, that he walked his dog on the foreshore ... and had identified noise from the wind turbines ...over 4 kilometres away from the site.'

Occasionally the family would request that one or more turbines could be switched off so that they could spend time in their garden, but:

'I found it beyond belief that after almost 4 years we still had to ask for time to work in our own garden and even then to be restricted to 4-5 hours.'

Member of Family 01

- 12 Other witnesses said that even without a view of the turbines, there is an audible impact:

'I cannot come to terms with the thought of this situation continuing for another 15 years. From our property we cannot see any of the turbines, but we can certainly hear them.' **Member of Family 02**

'They were noisy immediately, blades "whooshing" around ... if the wind is from the East, or the South, the noise is horrendous. You can't get away from the noise, where can you go? It's all around outside and you get it inside the house as well. It's worst during the night, I have to "bed hop" to get any sleep ... but it doesn't work ... This noise is like a washing machine that's gone wrong. It's whooshing, drumming, constant drumming, noise. It is agitating. It is frustrating. It is annoying. It wears you down. You can't sleep at night and you can't concentrate during the day ... It just goes on and on ... It's torture ... [4 years later] You just don't get a full night's sleep and when you drop off it is always disturbed and only like "cat napping". You then get up, tired, agitated and depressed and it makes you short-tempered ... Our lives are hell.' **Member of Family 03**

- 13 One resident near the wind farm, a mechanical engineer and his family, accepted the developer's assurance that the turbines would not be a noise nuisance. However, when the wind turbines became operational, they began to experience problems with noise. Following this, they then discovered that other families had similar problems. The developer denied that any problem existed:

'The wind farm was described as "inaudible", which clearly wasn't true. They also denied the existence of upwind noise, a fact they later retracted and admitted did exist ... at one of these meetings Mr ---, of ---, said ... that his company was not prepared to take any action to reduce or eliminate' the phenomenon of shadow flicker. 'Throughout the negotiations with the developer's side, it has been disappointing to encounter the amount of "stonewalling" and intimidation, which culminated in the threat of legal action against us, when our sole intention was to remedy the problems inflicted on us by the presence of the wind farm, which caused the various nuisances.' **Member of Family 04**

- 14 Another family living near the wind turbines, who had also been reassured by the developer prior to the installation that noise would not be a nuisance, did indeed experience a 'noise nuisance' when the turbines became operational. At a meeting, a representative of the developer, when asked about the problems with noise, especially after assurances that noise would not be a problem at this site, responded:

'... no wind farm was "inaudible". I suggested that any further correspondence publicising wind farms in general should, in future, be correctly worded and not mislead the general public in this way ... everything we were complaining about was being aggressively fought against by the developers ... My personal feeling is that the residents have been let down by all the parties involved, but specifically by the Environmental Health Department's apparent inability to resolve what is a genuine and distressing sequence of noise nuisances that have gone on now for over 4 years.' **Member of Family 05**

- 15 Yet another resident living near the wind turbines, although not visible from his home, found the noise from the turbines disturbing, especially when the wind prevails from the East, which is frequent:

'It was like the Chinese water torture, it was constant pulsating noise. I also had to move bedrooms on occasions in an attempt to escape the noise. It's a feeling as much as a noise ... It's an irritating and tiring noise, especially when you have not had any sleep because of it.' **Member of Family 06**

- 16 The litany continues: One resident, with many years work experience of oil and gas exploration, development, and production, including work as a consultant internationally, questioned the wisdom of installing wind turbines near homes. It was not the technology to which he objected. However, he felt reassured by the developer that the wind turbines would not create a nuisance, and that the developer would safeguard their 'continuing quality of life':

'It is not necessarily the noise level per se, but the nature of this noise. It may not be constant. It has lasted some 10 – 12 days without respite, with varying intensity such that even when not present you are waiting for it to re-occur.'

The most apt description is that it is an audio version of the Chinese Water Torture. The noise is such that the noise is felt as much as heard ... Developers have been informed ... that this noise is making people ill, although I have no experience of this. This, I believe, may be attributable to the low frequency element of noise created by the wind farm. This phenomenon is documented in a report published by DEFRA, where wind farms are confirmed as a source of low frequency noise.'

Member of Family 07

This particular resident was 'appalled' when the signatory of the developer's letter assuring the community that the wind turbines, when operational, would not create a noise nuisance, later admitted to him privately, that:

'There is noise with all wind farms. It is to be expected and you have to live with it.'

'This confirmed my worst fears that the residents had been misled ...'

- 17 Apparently, the developer eventually provided attempts at noise mitigation:

'This, I believe, is an admission that noise problems exist ... the developers want to dictate the times of day, duration and location of the residencies [sic] that will and will not be affected by noise emanating from their wind farm. This is entirely contrary to the [developer's] letter and the BWEA and EWEA guidelines ... It is also contrary to the EHO's mission statement as publicly depicted on their web site.' **Member of Family 07**

- 18 And from a farming family:

'The noise is a big "Whooshing" noise ... I hear it inside my home ... If I sit in the garden it's there, not always as it depends really on the wind direction and if the wind is from the west side of my property it is worse ... I am not against wind energy, but these are definitely in the wrong place. If only someone had come and looked at it or even if they came today, they would realise what I am trying to say.' **Member of Family 08**

- 19 **One family has since moved away; their home was 680m from the nearest wind turbine.**

Another family that has since moved away lived 700m from the nearest wind turbine.

Another family is moving away; they live 800m from the nearest turbine.

Of the other witnesses, distances from the nearest turbines range from 600m to 1000m. One resident, who lives 390 m away, sleeps with the radio on, but this person declined to testify.

- 20 **In a paper known as "The Darmstadt Manifesto", published in September 1998 by the German Academic Initiative Group, and endorsed by more than 100 university professors in Germany, the German experience with wind turbines is described in graphic terms:**

‘More and more people are describing their lives as unbearable when they are directly exposed to the acoustic and optical effects of wind farms. There are reports of people being signed off sick and unfit for work, there is a growing number of complaints about symptoms such as pulse irregularities and states of anxiety, which are known to be from the effects of infrasound [sound frequencies below the normal audible limit].’

- 21 In Bradworthy, North Devon, UK, noise complaints lodged to the local environmental health officer after three wind turbines – each 85m high [75m approved, built at 85m] – became operational in 2005, are still unresolved. One resident, who lives as near as 533m to these three turbines, endures

‘strobe or shadow flicker entering my Kitchen, Conservatory and Sitting room, all on the East side, when the sun rises in the east, in Autumn and Winter behind the wind turbines. This will last for three months and is NOT ACCEPTABLE ... The prolonged flicker causes a headache, affects my eyes and causes disorientation.’

This resident has observed and described the noise at various times of day, in all weather conditions, and rarely is there a lull in the noise, which is characterised, depending upon the strength and direction of the wind, as swooshing, swishing, whining, a constant aeroplane drone, a police siren, and like a spin dryer.

‘That shadow flicker would cause problems was denied 3 times in the planning appeal book.’ [MH, Bradworthy]

Yet, the developer’s Planning Appeal stated:

‘Shadow Flicker. As previously stated, this is not considered an issue due to the distance and orientation of the turbines to the nearest dwelling.’

Instead, this property owner explains that the shadow flicker *‘actually reaches past my property and over a public highway ... 500 metres away is too close.’* [MH, Bradworthy]

- 22 In a letter to the *Western Morning News*, 16 October 2001, Patrick and Phoebe Lockett, of Wadebridge, Cornwall, UK, wrote:

‘We live near the Bears Down windfarm in North Cornwall, where there are 16 turbines between 750 and 1400 metres from our home, and we are subjected to intrusive noise. When the wind direction is south to south-westerly, there is a rhythmic thumping sound which disturbs us and our neighbours, in our homes and gardens, day and night.

We are writing to residents in the areas of North Devon where there are proposed wind farm developments, advising them not to take reassurances from developers at face value.

I quote from a letter we received in October 1998 from National Wind Power’s head of operations and technology, John Warren:

“We are 100 per cent confident that there will be no noise problem at any nearby residence.”

NWP say that they do not know why the turbines are making this noise. They are monitoring it and tell us they will try some experimental adjustments to the turbine blades. Our only hope is that NWP's investigations will provide a solution to the distressing situation in which we and our neighbours find ourselves.'

- 23 Two years later, in a letter to the Western Morning News on 15 November 2003, Phoebe Lockett wrote:

'We are still experiencing noise problems with the turbines on Bears Down.'

- 24 *The Courier-Mail* (Queensland, Australia) reported on 4 October 2005, that a Queensland government-owned wind farm, which began operating in 2000, was creating sleep disturbances and noise problems at nearby properties. Jim and Dot Newman said:

'... the throbbing, thumping noise from the generators could be heard at all hours of the day. It was very frustrating in the beginning and makes us extremely upset, but there is nothing we can do about it.'

After a year, the couple decided to move, but could not find a buyer for their property. The newspaper reported that:

'A number of Victorian residents know exactly how the Newmans feel and are equally angry at Stanwell Corporation.'

Stanwell had assured residents that they would not be disturbed by the turbines.

With two 60m towers standing 750m and 810m from their homes, Keith and Terry Hurst said:

'It was terrible, we had real trouble sleeping and the worst part was we decided to move and it took 18 months to sell the place.' In a 'booming' property market, they lost money selling their house. One real estate agent said that 'it was nearly impossible to sell a property within one kilometre of a wind turbine or a proposed wind turbine.'

- 25 Stanwell's spokesperson said that:

'... independent experts and noise level monitoring had verified the Toora Wind Farm [as] fully compliant with its operating permit conditions.'

(Gregg N. Wind energy not resident-friendly. *The Courier-Mail*, Queensland, Australia, 4 October 2005.)

- 26 A common thread runs through these observations by those who live near wind turbines: It is not necessarily only the loudness of the noise; it is also the character of the noise that is disturbing. The wind turbine noise is periodic; intermittent; 'whooshing' or 'swishing'; it interferes with outdoor activities at one's home and with sleep or studying, i.e., it severely disrupts normal family life.

As one of those living near the wind farm in Askam observed:

‘You think “Oh it’s stopped” – then it starts up again.’
(Member of Family 09)

- 27 In New Zealand, a man may be forced from his home because noise from wind turbines will make his house ‘uninhabitable’. After 20 years, it is understandable he is reluctant to leave. However, the nearest of the planned twelve turbines is only 500m from his boundary, and the decibel levels will exceed those allowable, according to the state-owned power company’s representatives.
- 28 In 2005, a family living near the Te Apiti wind farm in New Zealand, had to move house because noise and vibration ‘*made it impossible for them to stay*’. [http://stuff.co.nz : *Turitea man fears he’ll have to go*. 10 November 2006]

Indeed, those living near the Te Apiti wind turbines have first-hand experience with those problems:

‘... in an easterly there is an intrusive rumble for days on end. They say the windmills emitted a low frequency noise for three days on end, making their lives a living hell.’

At another time,

“... the rumbling was so bad it sounded like one of those street cleaning machines was driving up and down near the house. In fact it sounded like it was going to come through the house,” said Wendy Brock.

- 29 According to Meridian, the developer:

‘... it’s a small number of people making a big noise about nothing.’

And another Meridian spokesperson, Alan Seay, said that:

‘... the monitoring has shown quite clearly they were well within the guidelines.’

[Flurry of complaints after wind change. TV1 News, New Zealand, 25 July 2005, <http://tvnz.co.nz/view/page/411749/599657>]

- 30 In Nova Scotia, Canada, one family and one wind farm developer have drawn different conclusions from similar noise readings at the family’s home. Although the family insists that the noise from the 17 wind turbines – the closest is 400m from their home – has affected their well-being, the developer does not acknowledge any deleterious effects on the family. [Keller J. Nova Scotians flee home, blame vibrations from 17 turbines for loss of sleep, headaches. Canadian Press, 13 November 2006, <http://thestar.com>]

The d’Entremont family complained of noise and low frequency vibrations in their house after the wind turbines began operation in May 2005. The inaudible noise deprived his family of sleep, gave his children and wife headaches, and ‘*made it impossible for them to concentrate*’. They now live nearby; if they return to their home, the symptoms return.

- 31 *'But a study released this month by the federal natural resources department, which oversees funding for wind farm projects, found no problems with low-frequency noise, also known as infrasound.'*

The government report concludes that the measurements:

'indicate sound at infrasonic frequencies below typical thresholds of perception; infrasound is not an issue'.

The developer says he was not surprised by the report's findings:

'It essentially says that there's no issue whatsoever with infrasound.'

- 32 D'Etremont hired his own consultant to record the noise levels at his home:

'Gordon Whitehead, a retired audiologist with twenty years of experience at Dalhousie University in Halifax conducted tests.'

Whitehead's data was similar to that of the government's report. However, as a health professional, Whitehead reaches a different conclusion:

*'They're viewing it from the standpoint of an engineer; I'm viewing it from the standpoint of an audiologist who works with ears ... The report should read that (the sound) is well below the auditory threshold for perception. **In other words, it's quiet enough that people would not be able to hear it. But that doesn't mean that people would not be able to perceive it.**'*

Whitehead explains that

'... low-frequency noise can affect the balance system of the ear, leading to a range of symptoms including nausea, dizziness and vision problems. It's not perceptible to the ear but it is perceptible. It's perceptible to people with very sensitive balance mechanisms and that's generally people who get very easily seasick.'

- 33 The developer has acknowledged that some questions remain:

'From our perspective, I think it's really up to the scientific community to really address and research such issues (as low-frequency noise) ... I know there is research that points to different directions.' [Keller J. Nova Scotians flee home, blame vibrations from 17 turbines for loss of sleep, headaches. Canadian Press, 13 November 2006, <http://thestar.com>]

- 34 In a newspaper article describing the d'Etremonts' situation and the wind power company's position, Michael Sharpe, a Dalhousie University audiologist, said that:

'Even if someone isn't affected directly by low-frequency noise, the constant swoosh of the blades, even at allowable levels, can have psychological effects.'

"If the sound is audible and it annoys you, then it can seem louder," says Sharpe who compares it to a dripping tap that can keep someone awake at night.

“As your stress level increases, your awareness of the annoying sound increases as well. As we know, elevated stress levels for a prolonged period of time can have a negative health effect.” [Keller J. Turbines stir up debate. *The Chronicle Herald*, Halifax, Nova Scotia 21 May 2006.]

35 The d’Etremons are unable to sell their home because of the wind farm. [Keller J. Nova Scotians flee home, blame vibrations from 17 turbines for loss of sleep, headaches. *Canadian Press*, 13 November 2006 <http://thestar.com>]

36 Dr Robert Larivee, a Professor of Chemistry who lives 3000m east of twenty wind turbines – commissioned in 2003 – in Meyersdale, Somerset County, Pennsylvania, USA, wrote to his County Commissioners (2005) after an acoustician measured noise at his property that rose to 75 dB.

‘These levels are much higher than those predicted by the company. There are a number of reasons that may contribute to this. Probably the most significant factor is the topology of the area. Our area has many mountains and valleys ...’

Dr Larivee quotes the US Environmental Protection Agency, which says that

‘noise levels above 45 dB(A) disturbs sleep and most people cannot sleep above the noise level of 70 dB(A). Emotional upset, irritability and other tensions, may also arise. Noise contributes to ailments like indigestion, ulcers, heartburn and gastrointestinal malfunction in the body.’ [Letter from Dr Robert Larivee, Meyersdale, Pennsylvania, USA, to the County Commissioners <http://www.pbase.com/wp/image/39285457>]

37 Another resident of Meyersdale, who lives less than one mile from the twenty wind turbines, wrote a lengthy letter on 7 March 2006 to ‘Interested Parties’. Karen Ervin felt she had to *‘share the realities and impacts’* of living near a wind turbine facility. She calls her situation the **“Human Experimental Factor”**, as the community deals with *‘the multiple nuisances and issues’* affecting her family, her neighbours, and local adjacent property owners during the two years the wind turbines have been operating:

‘Prior to the building of the facility, our neighbors and we were never made aware of the nuisances that occur with a wind turbine facility. The noises emitted from the turbines have definitely changed our style of living. The noises produced from the blades turning on the turbines create a ‘threshing’ sound within and around our home as well as the adjacent properties ...’

‘At times it is difficult to fall asleep with the “pounding” of the turbines. One is often awakened by the ‘droning’ noise of the turbines, finding it most difficult to fall back asleep. The noise becomes so disruptive; one can concentrate on nothing else but the constant droning. During the winter months, the noise is quite unbearable at times, sounding like drums beating constantly in the background. During the summer months, we cannot have our windows open ...’

‘Advocates for these facilities will often compare this “threshing” noise to the “peaceful” sound of waves beating against the rocks at the seashore; but I

have been to the seashore and it certainly is in no way comparable to the “calming sound” of waves.’

Noise is not the only problem: flicker and ‘strobing’ are also nuisances. Ms Ervin concludes her letter with this observation:

‘This industry without stringent regulations can be truly labelled a “Pandora’s Box”. Be careful for what is opened, and be prepared for the negative impacts that have occurred and continue to occur with this industry.’
[Letter, Karen Ervin, Meyersdale, Pennsylvania, USA, 7 March 2006, www.pbase.com/wp/image/39285457]

- 38 Yet another resident living near the Meyersdale wind turbine facility, Mr Rodger Hutzell, Jr, and his family experienced

‘... noise nuisance issues, specifically when trying to go to sleep at night. The noises are greater during the winter months. The noise appears to correlate to a continual droning sound. When awakened at night, there are times that is impossible [sic] to get back to sleep due to the threshing sounds produced by the wind turbines.’ [Letter, Rodger A Hutzell, Jr, Meyersdale, Pennsylvania USA, 13 February 2005, www.pbase.com/wp/image/39285457]

- 39 In Mackinaw City, Michigan, USA, wind turbines rise 325 feet high, visible from nearby homes. Kelly Alexander’s home is ¼ mile away from the nearest turbine. Initially Mr Alexander was in favour of the turbines, especially after the developer’s assurances that the wind turbines would not be noisy. Flicker is also a problem, but this was never mentioned by the developer to Mr Alexander or the community.

Once the turbines became operational, Alexander heard

‘a constant humming sound inside his home when the turbines are running, whether the windows are open or not. He said the situation was unliveable and all he wants is for things to be the way they were ...’

- 40 **The wind energy company representative said that it ‘has lived up to ordinance requirements.’**

Alexander’s response was:

‘Stop lying about these turbines. Tell people the truth.’
[Holland Sentinel, 31 December 2002]

- 41 In September 2002, the Mackinaw *Journal* reported on these turbines. Danny Dann and Kelly Alexander said that the turbines ‘were exceeding a 60-decibel noise limit’, and that ten other immediate neighbours were also concerned about the noise. The Mackinaw City Community Development Director said that they had sought legal advice because they did not have ‘anything in our lease agreement to terminate the contract.’

- 42 The owner, Bay Windpower, planned to erect at least two more wind turbines in the same area. [McManus S. Turbines still causing a problem, neighbors say. *Mackinaw Journal*, August 29 – September 26, 2002, p 3]

- 43 In 2004, Dr James LeFanu wrote that *‘there have been some interesting comments on the substantial health problems – headaches, anxiety, sleep disturbances’* experienced by those living near wind farms:

‘The cause seems to be the low-frequency noise generated by the incessant throb of their turbines (“like a concrete mixer in the sky”). “I like to think I know a bit about sound,” writes Basil Tate, a recording engineer from Cornwall, “but it always amazes me how my wife can feel low-frequency sounds that are a long way away and be extremely distressed by them.” Little wonder that some of those living close to wind farms have been forced to flee their homes.’ [LeFanu J, Dr. In sickness and in health. *Daily Telegraph* 14 March 2004]

- 44 Unhappily, this is not an exaggeration. Gwen Burkhardt was surprised when Dewi Jones, director of Windjen, which runs Blaen Bowi wind farm in Wales, UK, said:

‘There are a lot of wind farms operating in the UK and we haven’t come across the complaint before.’ [‘Did turbines make you sick? *Journal* 18 May 2005, www.thisissouthwales.co.uk]

In her letter to the *Journal* [1 June 2005], Ms Burkhardt wrote that:

‘I spoke to you and two of your employees on March 10 this year ... I explained to you in great detail about my own illness which was also brought on by the low frequency sound emitting from the very same turbines.

It has caused me and my family a great deal of distress and has resulted in us having to move away from the area where I was born and where we have farmed for the last 27 years. Have you just forgotten our conversation? Do you simply not care? ... I do remember you sympathising with me and also telling me that you would not like to live near the turbines yourself.’
[Burkhardt G. Complaints are not new. *Journal*, 1 June 2005, www.thisissouthwales.co.uk]

- 45 In July 2005, Mr Murray Barber wrote to inform Energiekontor AG about the noise problems at the Forestmoor wind farm near Bradworthy, Devon, UK. His family’s home, located 650m from the nearest of three turbines, is affected especially during calm days when the noise is very audible.

‘The noise nuisance caused is irritating, distracting, stressful ... We do not understand why it is necessary for all three turbines to be driven at a high speed of rotation in absolute still air.’ [Letter from M Barber to Energiekontor AG, 12 July 2005]

In response, Energiekontor AG informed Mr Barber that:

‘The threshold of hearing is considerably lower than these levels, so noise from the turbines will be audible, however, at a level which is considered by the guidelines not to unduly affect amenity.’ [Letter to M Barber from Energiekontor AG 19 July 2005]

- 46 In Fenner, New York, USA, when the trees are bare, Wayne Danley's wife 'flees' the living room of their house because of the flicker created by the turbine's rotating blades. Mr Danley lives 900 feet from the nearest wind turbine:

'It sounds like a train going through, except the train never comes through ... It's too close.' [Neighbors complain of wind farm nuisances, The Albuquerque Tribune, 28 April 2006]

In response, Marion Trieste, publicist for the Alliance for Clean Energy New York, said:

'There's a lot of misinformation, and a lot of inflamed discussion about negative encroachment.' (Neighbors complain of wind farm nuisances, The Albuquerque Tribune 28 April 2006)

And according to Laurie Jodziewicz, a policy specialist for the Alliance, **there are complaints about the 'strobe-light effects, but those occur only during certain months of the year and depend on the sun's angle to the turbine blades.'** (Neighbors complain of wind farm nuisances, The Albuquerque Tribune 28 April 2006)

- 47 Given the sophistication of engineering design computer modelling, one might presume that these effects could be calculated prior to the construction of the wind turbines. However, Mr Danley had it right: the wind turbine was too close. With appropriate planning and distances between homes and wind turbines, these problems would not only be attenuated, they would cease to exist.

"It's not there all the time, but you're always waiting for it ... [It's] totally infuriating.'

The thump-thump-thump 'reverberates up to 22 times a minute,' said Les Nichols, who lives beside a wind farm in Askam, Furness, UK. When seeking permission for the seven turbines, the developers '*guaranteed there would be no noise nuisance.*' (Garrett A. Ugly side of wind power. The Observer, Sunday, March 2, 2003)

- 48 Yet Bruce Allen, a director of Wind Prospect, the management company for the owner, PowerGen Renewables, said that:

'The wind farm "had not breached its planning requirements. It's a subjective thing – like living beside a busy road." (Garrett A. Ugly side of wind power. The Observer, Sunday, March 2, 2003)

Garrett's article continues:

Giant wind turbines '*planted on your doorstep ... can transform a tranquil neighbourhood overnight into a menacing industrial site ... there are no rules about how close they can be to homes.*'

'The Welsh Affairs Select Committee recommended they shouldn't be less than 1.5 kilometres (0.93 miles) from any house, but developers generally go as close as between 500 metres (1,640 ft) and 600 metres (1,968 ft) ...' (Garrett A. Ugly side of wind power. The Observer, Sunday, March 2, 2003)

- 49 As Phoebe Lockett, who lives near the Bears' Down wind farm in Cornwall, UK, wrote in a personal communication:

'There seems to be little known of what noise there may be from wind turbines and very few people who have genuine expertise in this area. The planning guidelines and studies carried out beforehand are, in my opinion, of little use.'

'Please let me know if I can be of further assistance, as I do not like to think of others having to go through the same distress.' [Letter, personal communication, 15 November 2003]

- 50 Eleven wind turbines, 121m high, have been operating in Taurbeg, Cork, Ireland, since February 2006, where residents *'are anything but happy ...'* The noise from the turbines are causing sleepless nights; one resident said the noise was like a *'plane which consistently hovers but never lands.'*

Another resident told the newspaper that *'The thought of another six going up within 500 metres of my front door is just a nightmare ... The noise from the windmills kept everybody in the area awake.'*

There were a number of complaints about the inaccuracies of the photomontages produced by the developer during the application process. Residents also suffer flicker, and one person labelled the result *'visual chaos'*. [Herlihy M. Windmills 'are a nightmare'. The Corkman, 6 April 2006]

- 51 In the summer of 2006, eight wind turbines with an installed capacity of 16MW became operational at Deeping St Nicholas, Lincolnshire, UK. The noise from these turbines transformed the lives and the livelihood of the Davis family, living in a farmhouse only 907m from the nearest turbine. Jane and Julian Davis, who farm at Deeping St Nicholas and who learned of the development while reading their local newspaper, did not object to the development. They support wind energy and believe that renewable energy sources are essential to preserving the environment.

Although the Davis family cannot see the wind turbines from their home, the noise – both inside and outside their home, and which also caused vibrations within the structure of their home – has had a deleterious impact on their health and sense of well-being. Prior to the wind farm, they had no problems sleeping through the night. Now, when the wind blows from the southeast or the southwest, the noise from the acoustic radiation seriously disturbs their sleep.

'They have spent more than 60 nights in the last six months sleeping at friends' houses', and when home, they 'are existing on less than four hours sleep a night and sometimes a lot less.' [Couple driven out of home by wind farm. Spalding Today (UK) 21 December 2006]

After taking its own acoustic readings, the local Council confirmed the noise problem, and it is investigating the matter further. [Davis J. Personal communication, 19 January 2007]

Local land agents have told them that their property is ‘unsaleable’. Although consultants for the developer are evaluating the issue, and the Dti are investigating wind farm noise, that does not alleviate the impact on the family. [Tasker J. ‘Wind farm noise is driving us out of our house.’ Farmers Weekly 12 January 2007]

As the noise established itself as an ongoing problem, the Davis family learned that developers had used only predicted levels for their home without taking actual baseline measurements. Indeed, background noise most often measured below 20 dB at night (and usually in the range of 14 dB); now noise in the range of 40 dB occurs when the wind shifts to the southeast or the southwest, and on occasion, the noise has measured over 60 dB. [Personal Communication, 19 January 2007]

Quite generously under these circumstances, the Davis family continue to support wind energy but believe that wind turbines must be sited further from homes because the noise level and the impact of the noise cannot be accurately predicted. Jane Davis says that:

‘More needs to be done if wind power is to become a viable alternative source of energy. It is a national issue and the Government ought to be doing more about this if we need lots more wind power.’ [Spalding Today (UK) 21 December 2006]

The Environmental Statement that accompanied the developer’s application said that there would be no noise. [Davis J. Personal communication, 19 January 2007]

Meanwhile, Jane Davis says that she and her family are literally **‘fighting for our lives.’** [Personal communication, 19 January 2007]

- 52 These are the voices and concerns of people who are despairing. However, with civic spirit, they speak out to alert others to the realities of living near wind turbines. As Bell noted in his 1966 report on noise for the World Health Organization:

‘Anti-noise campaigns serve a useful purpose in focusing public attention on the matter; they provoke discussion and are often a stimulus to positive control measures.’

- 53 According to Dr Dilys Davies, consultant clinical psychologist:

‘Noise problems can lead to ill health’, leaving the person ‘more easily disturbed by noise in the future ... There is pressure on the heart, your breathing and whole arousal system. Your muscles tense as you wait for the noise, and if you are not careful you get used to being in that state constantly ...’ [Aitch, I. Keep It Down. Telegraph, 2 December 2006]

- 54 Many of those affected by wind turbine noise believe that the developers and decision-makers of the State have misled them. One explanation might be that the methodology for calculating the disturbance levels created by wind turbines at nearby homes is woefully inadequate, concentrating almost entirely on audible sound levels while dismissing other noise characters with a ‘penalty in the

condition' [Planning Approval], which has produced unreliable information. The consequent release of noise pollution on people's homes produces sleep deprivation and other health injury, and the adverse effects are entirely avoidable.

There appears to be a total 'disconnect' between the experiences of those living near wind turbines and those who have a commercial interest.

- 55 The natural commercial instinct of developers is to maximise development potential from land, thereby leaving the minimum distance between turbines and homes. This presumes reliability and certainty in determining the physical impacts on families. However, such reliability and precision in calculating the effects does not exist, as the wind energy industry itself notes in its professional literature. (See Section 4.0, Acoustics, of this paper.)
- 56 It is too easy to dismiss the reports of noise disturbances and flicker effects by people living near turbines. Yet these problems emanate from many people in many countries, living in varied topographies, with one thing in common: they all live in close proximity to wind turbines.
- 57 It is somewhat hypocritical of public officials to decry the despoiling of the environment on a global basis, while ignoring the despoiling of the environment – including noise pollution – on a local level. At what point will officials and government agencies respond to these issues that involve the genuine – and avoidable – suffering of those living near wind farms? **At the least, further investigation into the health effects is warranted, with a minimum buffer zone of 2km between the nearest wind turbine and any dwelling.**

Section 4.0 ACOUSTICS

Acoustic Radiation experienced by people living near commercial wind turbines

- 1 In 2004, a small group met to consider the likely cause of adverse health effects reported by families where developers built wind turbines too close to their homes. Prof James Lovelock, retired NASA scientist and Harvard Medical School; Prof Ralph Katz, Chair, Department of Epidemiology and Health Promotion, New York University; Dr Amanda Harry, physician; and Dr David Coley, acoustician, Exeter University, decided the relationship was most likely to be an acoustic radiation of sound characters, which in combination unbalanced the natural function of the human body.
- 2 The reason for this is that the human ear responds not only to ‘loudness’, that is, sound pressure, measured in decibels – dB – with which many people are familiar, but also to sound frequency, measured in Hertz (Hz). [WHO Fact Sheet No 258, 2001]. In addition, sound affects the human body itself; even when a sound is ‘inaudible’ to the ear, the character of the sound may affect the body.
- 3 While the wind energy industry seeks to dismiss the adverse health effects reported by families living near wind turbines, there is ample evidence from medical research that noise in diverse circumstances can indeed have a negative impact on health. Noise can induce adverse physical and/or psychological symptoms. The qualities of the symptoms are similar to the complaints of those living near wind turbines. The phenomena may be produced intentionally, e.g., in a laboratory or in a specific instance, or unintentionally by the interaction of technical events, as with wind turbines.
- 4 Military weaponry exists that relies on low-frequency sound to disperse crowds or control crowd behaviour. [The Cutting Edge: Military Use of Sound, The Toronto Star (Canada), 6 June 2005] The effect of low-frequency noise at high intensities creates discrepancies in the brain, producing disorientation in the body:

‘The knees buckle, the brain aches, the stomach turns. And suddenly, nobody feels like protesting anymore. The latest weapon in the Israeli army’s high-tech tool kit.’

‘The intention is to disperse crowds with sound pulses that create nausea and dizziness. It has no adverse effects, unless someone is exposed to the sound for hours and hours.’ [The Toronto Star, 6 June 2005]

- 5 Hillel Pratt, a professor of neurobiology specializing in human auditory response at Israel’s Technion Institute, said,

‘It doesn’t necessarily have to be a loud sound. The combination of low frequencies at high intensities, for example, can create discrepancies in the inputs to the brain.’ Such technologies produce ‘simulated sickness’.
[Pratt H. Personal communication, 14 March 2006]

In a subsequent communication, Prof Pratt explained that:

‘... by stimulating the inner ear, which houses the auditory and vestibular (equilibrium) sensory organs with high intensity acoustic signals that are

BELOW the audible frequencies (less than 20Hz), the vestibular organ can be stimulated and create a discrepancy between inputs from the visual system and somatosensory system (that report stability of the body relative to the surroundings) and the vestibular organ that will erroneously report acceleration (because of the low-frequency, inaudible sound). This will create a sensation similar to sea or motion sickness. Such cases have been reported, and a famous example is workers in a basement with a new air-conditioning system that all got sick because of inaudible low frequency noise from the new system.'

[Pratt H. Personal communication, 15 March 2006]

- 6 Wind turbines create these unintentional acoustic effects via the confluence of their design and operation. Noise, including low frequency noise, are long-standing issues with wind turbine design and operation. The wind turbine interacts with the topography, meteorology, spatial structure of the site, and with other wind turbines on the site. As an example of this unintentional confluence: Wind turbines produce visual flicker and strobe effects at certain times of the day, an effect similar to driving by a stand of trees when the sun is behind them. Acoustic characters and visual characters can combine and induce body 'disharmony'. Dr Bucha first identified this effect in the 1950s, after he was asked to investigate a series of unexplained helicopter crashes.
- 7 The pilots surviving the crashes reported feeling fine until the sudden onset of nausea and dizziness. During the episode, pilots lost control of their aircraft. Bucha found that when the blades maintained a rotational rate for sufficient time, the resulting strobe effect of sunlight closely matched human brainwave frequencies. The 'Bucha effect' is a seizure-inducing effect of light flashing in high frequency, similar to epilepsy but without being restricted to a small fraction of the population.
- 8 In "Present Status of Aeroelasticity of Wind Turbines", a report by Flemming Rasmussen and his colleagues at the Riso National Laboratory, Denmark, the authors observed:

"The term aeroelasticity is inherited from aeronautical engineering, and applying this with respect to wind turbines also makes an association to the high level of technology. From this perception the wind turbine is a helicopter. The operation of the flexible rotor in the turbulent atmospheric boundary layer is influenced by the control actions involves many of the same phenomena." [Rasmussen F; Hartvig Hansen M; Thomsen K; Larsen TJ; Bertagnolio F; Johansen J; Aagaard Madsen H; Bak C; Melchior Hansen A. Present status of aeroelasticity of wind turbines. *Wind Energy* 2003; 6(3):213-228]

- 9 The military has made use of the combination of visual and acoustic characters to control behaviour. A report of the United States Air Force Institute for National Security Studies identifies and describes numerous non-lethal techniques. Among those that pertain to acoustic and/or optical effects on human physiology, several share characteristics with wind turbine noise and visual effects. [Bunker RJ, ed. Nonlethal Weapons. USAF Institute for National Security Studies, INSS Occasional Paper 15, July 1997].

'Acoustic infrasound: very low frequency sound which can travel long distances and easily penetrate most buildings and vehicles. Transmission of long wavelength sound creates biophysical effects, nausea, loss of bowels, disorientation, vomiting, potential organ damage or death may occur. Superior to ultrasound because it is 'inband', meaning it does not lose its properties when it changes mediums such as air to tissue. By 1972 an infrasound generator had been built in France, which generated waves at 7Hz. When activated it made the people in range sick for hours.'

Techniques include:

- a. Bucha effect: high intensity strobe lights that flash at near human brain wave frequency causing vertigo, disorientation and vomiting.
 - b. Stroboscopic device: devices employed against demonstrators that use stroboscopic flashing; same principle as a discotheque strobe. In the 5 – 15Hz range, these devices can cause various physical symptoms and in a small portion of the population may trigger epileptic seizures.
 - c. Lag time: The physiological time lag that occurs between the time a stimulus is perceived until the body responds. In a healthy, well-rested human, this takes about three-quarters of a second.
 - d. Sensory overload: A temporary inability of an organism to correctly interpret and appropriately respond to stimuli because of the volume of the input.
10. Although the military examples use acoustic and visual devices that intensify physiological reactions, the noise and visual effects of wind turbines produce similar physiological reactions. Indeed, the physical complaints of those living near wind turbines share symptoms, though fortunately, not at the levels induced by the military devices. Unfortunately, those individuals living near wind turbines experience the adverse effects without remission. Additionally, military use relies upon high dosage over a short time span. Unintentional occurrence, as with wind turbines, produces a small dose over a long time-span with apparent compounding similar effects.
11. Another example of military use of LFN is called SONAR (SO(und) NA(vigation and R(anging)). In "*Navy adapts sonar to protect whales*", The Sunday Times reported on 26 March 2006, that amid evidence that navy sonar was causing whale and dolphin deaths by confusing them so that they would surface too quickly *'that they suffer fatal attacks of the 'bends'*:

'Navy warships are to be equipped with a £2.5m scanning system to spot marine mammals after post-mortem tests linked the death of beached whales to military sonar.'

The use of military sonar appears to interfere with the echo-location system the animals use to navigate, leaving them so disorientated they misjudge depths and swim to the surface too quickly.

The low frequency system will operate at long range and the MOD admits it has the potential to be harmful to marine life. Liz Sandeman, co-founder of

Marine Connection, a conservation group, said, "Low frequency sonar can travel for hundreds of miles, yet the marine animal detection system will only work for two miles".'

12. Following the publication 'Noise annoyance from wind turbines – a review' [Pedersen E, August 2003], Pedersen et al published an article in August 2004, 'Living close to wind turbines – a qualitative approach to a deeper understanding'. [Pedersen E; Persson Waye K; Hallberg LRM. Proceedings of InterNoise2004, Prague, 2004]

The authors state that:

- a. *'Informants annoyed by wind turbine noise perceived the impact of turbines as a serious intrusion of their privacy. The force of the violation experienced was partly determined by the informants' conception of the living environment as a place where audible and visual impact from wind turbines did not belong. Categories increasing or decreasing the intrusion were experiences of not being believed, being subjected to injustice, lacking influence, and being out of control.'*
- b. *'Surprisingly many respondents reported themselves as annoyed by wind turbine noise at rather low A-weighted sound pressure levels (dB), compared to other sources of community noise such as traffic noise ... One hypothesis is that wind turbine sound has special characteristics such as amplitude modulations that are easily perceived and that could lead to annoyance even at low sound pressure levels (dB). Furthermore, in earlier laboratory studies where noise from different wind turbines were compared, the most annoying noises were predominantly described by the subjects as "swishing", "lapping", and "whistling".'* [Persson Waye K and Ohrstrom E. Psycho-acoustic characters of relevance for annoyance of wind turbine noise. Journal of sound and vibration 2002; 250(1): 65-73]
- c. *'An interesting observation was that other responses due to wind turbines, such as annoyance of shadows from rotor blades, seemed to interact with the noise dose-response relationship indicating that exposure to noise from wind turbines should be studied within its context'. [Pedersen E and Persson Waye K. Audio-visual reactions to wind turbines. Proceedings of Euronoise 2003; 5th European Conference on Noise Control, May 19-21, 2003, Naples, Italy, 2003]*
- d. In describing the results of interviews with the study group living close to wind turbines, the report says that:

'For some informants, the exposure reached further, not only intruding their home environment but also into themselves, creating a feeling of violation of them as a person. They expressed anger, uneasiness, and tiredness, disclosing being under strain, using a tense voice and sometimes crying when talking about the impact of the wind turbines.'

To be affected by the turbines to such a high degree, not being able to protect oneself from the intrusion that constantly raised negative emotions was experienced as a serious decline in well-being and life quality.'

13. In their article, ‘Aeroacoustics of large wind turbines’, Hubbard and Shepherd observe that buildings are affected by noise transmitted by wind turbines:

*‘The transmitted noise is affected by the mass and stiffness characteristics of the structure and its dynamic responses and the dimensions and layouts of the rooms. Minimum noise reductions occur at frequencies near 10Hz, probably because of associated major house structural resonances. This frequency range of low noise reductions unfortunately coincides generally with the frequency range of the intense rotational harmonics. **Noises in this low-frequency range will probably not be heard by human observers but may be observed indirectly as a result of noise induced vibrations of the building structure or furnishings.**’*

[Hubbard HH; Shepherd KP. Aeroacoustics of large wind turbines. JASA Journal of the acoustical society of America 1991 June; 89(6): 2496 – 2508, p 2505]

14. In ‘Noise induced house vibrations and human perception’, Hubbard’s research indicates that:

a. *‘A person inside the house can sense the impingement of noise on the external surfaces of the house by means of the following phenomena: **noise transmitted through the structure ... vibrations of the primary components of the building such as the floors, walls and windows; the rattling of objects ...**’*

b. Addressing the issue of ‘whole body perception’, Hubbard refers to the ISO Guidelines and says that a noise level outside a building between 55 – 60 dB (around 0.001 rms) in a frequency range of 0.1 Hz – 80 Hz, is the *‘Most sensitive threshold of perception of vibratory motion by humans’*.
[Hubbard HH. Noise induced house vibrations and human perception. Noise control engineering 1982; 19(2): 49 – 55]

15. In ‘Do wind turbines produce significant low frequency sound levels?’ [2004], GP van den Berg, observes that:

*‘Windows are usually the most sensitive elements as they move relatively easy because of the low mass per area. Perceptible vibrations of windows may occur at frequencies from 1 Hz to 10 Hz when the incoming 1/3 octave band sound pressure level is at least approaching 52 dB; at higher or lower frequencies a higher level is needed to produce perceptible vibrations. As can be seen in figures 1 –3 sound pressure levels above 60 dB at frequencies below 10 Hz occur close to a **turbine as well as 750 m distance and further.**’* [van den Berg GP. Do wind turbines produce significant low frequency sound levels? 11th International Meeting on Low Frequency Noise and Vibration and its Control, Maastricht, The Netherlands, 30 August – 1 September 2004. See also Stephens DG; Shepherd KP; Hubbard HH; Grosveld F. Guide to the evaluation of human exposure to noise from large wind turbines. NASA National Aeronautics and Space Administration, Langley Research Center, Hampton, Virginia (USA), NASA-TM-83288, March 1, 1982.] [emphasis added]

16. In 2003, the new International Standard for ‘Equal Loudness Level Contours’ was agreed (ISO 226:2003). In a comparative study with previous curves, Advanced Industrial Science and Technology (AIST) observed:

‘Between the new and the previous standards, very large differences are recognised up to about 15dB (decibels) for a wide area of frequency region lower than 1KHz (1,000Hz).

A difference of 10dB means a 10 fold difference in sound energy and that of 15dB corresponds to a 30 fold difference (fig 1).’

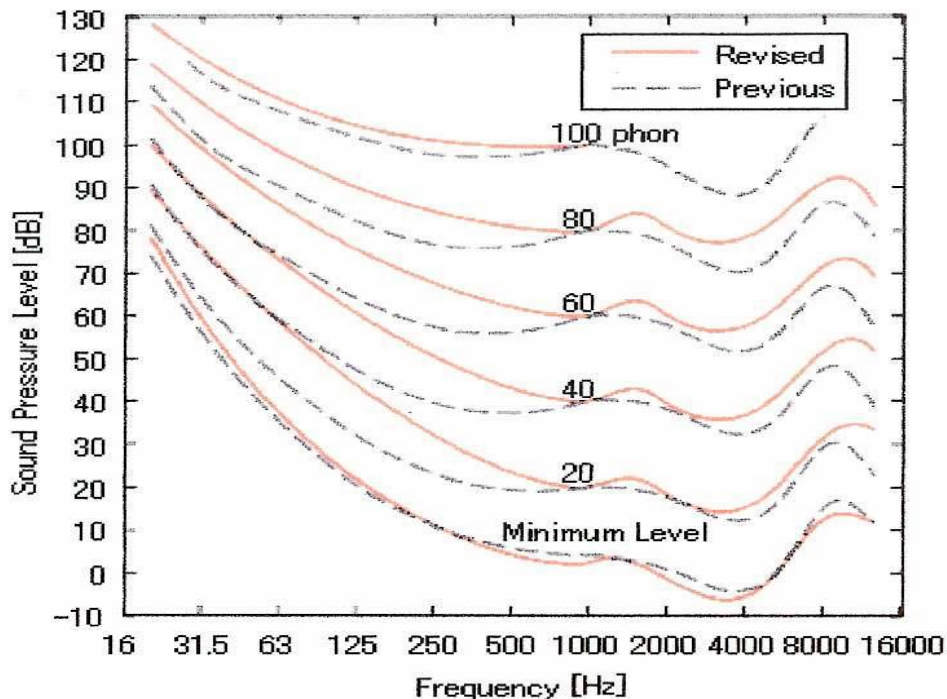

Fig. 1. Comparison between the new and the previous characteristics of equal-loudness-level contours. Remarkable differences are observed in the low frequency range.

Source: AIST. Full revision of International Standards for Equal-Loudness Level Contours (ISO 226), 2003 <http://www.aist.go.jp>

[Note: The threshold of hearing at about 20 Hz is circa 75dB.]

17. In a report by Dr D Manley and Dr P Styles, “Infrasound Generated by Large Sources”, the authors discussed a test conducted near a wind farm in October 1994, using only vibration analysis equipment. Measurements were taken between 0.75 miles and 2 miles downwind of the wind farm at the same elevation:

‘Wind speed was about 20 knots, and it was possible to hear turbines with a characteristic ‘beat’ (at about 0.8Hz) ...

The blade rotation was usually timed at 43 rpm and therefore the main seismic wave is related to the rotational period of the three bladed machine.

All three transducers show (from a typical frequency spectra) that there are odd numbered harmonics of the fundamental blade rotation frequency (0.8Hz, 2.4Hz and 4.0Hz being examples).

In March 1995 experiments were repeated in eight places, in a location 0.75 miles UPWIND of the wind farm, with a 20 knot wind. The speed of turbine blades was visually measured at 43 rpm. The results clearly show a second harmonic (a higher harmonic) spaced 2.15 Hz ...

[Manley DMJP; Styles P. Infrasound generated by large sources. Proceedings of the Institute of Acoustics 1995; 17:239 – 246]

18. Wind turbines radiate noise not only above ground; they also radiate noise below ground. Following his investigations of ground vibration at the Eskdalemuir seismic monitoring facility in Scotland, Professor Peter Styles, in a summary report to the Defence Estate, made these recommendations:

- a. *To 'define an exclusion zone of 10 km within which no windfarm / turbine development is acceptable.'*
- b. *'Between 10 and 50 km the TOTAL permitted windfarm / turbine generated seismic rms amplitude should not exceed 0.25 rms measured at Eskdalemuir' [the recipient].*
- c. *'This is best illustrated with two hypothetical examples:*
 - i. *'A single windfarm of 3 (no.) x 1.8 MW turbines located at 15 km from Eskdalemuir will produce a predicted rms amplitude of 0.20 nm.'*
 - ii. *'A single windfarm of 17 (no.) x 2.5 MW turbines located at 26 km from Eskdalemuir will produce a predicted rms amplitude of 0.11 nm.'*
[Styles (Keele University). Summary Report to Defence Estates, 3 March 2004]
- d. *'We have clearly shown that wind turbines generate low frequency sound (infrasound) and acoustic signals which can be detected at considerable distances (many kilometres) from wind farms on infrasound detectors and low frequency microphones.'*
[Styles P; Stimpson I; Toon S; England R; Wright M. Microseismic and infrasound monitoring of low frequency noise and vibrations from windfarms: recommendations on the siting of windfarms in the vicinity of Eskdalemuir, Scotland. Keele University (UK), Report for the Ministry of Defence, 18 July 2005]

19. The July 2005 Report by Prof P Styles, et al, "Microseismic and Infrasound Monitoring of Low Frequency Noise and Vibrations from Windfarms" commented:

"When the windfarm starts to generate at low wind speeds, considerable infrasound signals can be detected at all stations out to c 10km. Clear harmonic components which are the second multiple and up of 1.4Hz (the blade passing frequency) can be seen although interestingly and somewhat enigmatically the blade passing frequency itself is not so strongly detected".
[p 66]

"We have clearly shown that both fixed speed and variable speed wind turbines generate low frequency vibrations which are multiples of blade passing frequencies and which can be detected on seismometers buried in the ground at significant distances away from the wind farms even in the

presence of significant levels of background seismic noise (many kilometres).” [p 76]

In answer to the question: *“If we have a wind farm of N turbines, how does the seismic amplitude increase as compared to 1 turbine?”*

Answer: *“We have shown it varies as the square root of N and this is to be expected because the turbines are not all in phase and neither are they operating at exactly the same frequency because of the slight possible variations in rotation speed and also wind conditions across the farm. There is also a possible 10% variation in speed (Optislip) which will cause broadening of the spectral peaks. They are quasi-random sources and therefore add as square root of N. Therefore 100 turbines are 10 times as noisy as one, not 100 times.” [p 77]*

[Styles P; Stimpson I; Toon S; England R; Wright M. Microseismic and infrasound monitoring of low frequency noise and vibrations from windfarms: recommendations on the siting of windfarms in the vicinity of Eskdalemuir, Scotland. Keele University (UK), Report for the Ministry of Defence, 18 July 2005]

‘The Effect of Windmill Farms on Military Readiness’, a 2006 report by the US Department of Defense for the US Congressional Committees, supports Styles et al for the seismographic methods and devices used to measure low frequency noise and vibration at Eskdalemuir.

However, the Department of Defense report recommends that the United States modify the approach:

‘Measurements of seismic noise generated by wind turbines that Styles made must be updated to reflect the increased size of SOA wind turbines.’
(SOA = State Of the Art) [United States Department of Defense. The effect of windmill farms on military readiness. Report to the Congressional Defense Committees. Office of the Director of Defense Research and Engineering, US Department of Defense, 2006, p 62]

20. Moreover, Hubbard and Shepherd (*‘Aeroacoustics of large wind turbines’*, 1991) observe in their discussion on Atmospheric Propagation,

‘Acoustic refraction that arises from sound-speed gradients associated with atmospheric wind and temperature gradients, can cause non-uniform propagation around a sound source.’

In an *‘illustration of the effects of atmospheric refraction, or bending of sound rays, caused by vertical wind sheer gradient over flat homogeneous ground for an elevated point source’*, the rays are bent toward the ground in a downwind direction. That is, the ground can act as a large and effective microphone at low frequencies.

21. The WHO *Guidelines for Community Noise 1999* (S.4.2.1) say that:

“Reverberation times below 1 s are necessary for good speech intelligibility in smaller rooms; and even in a quiet environment a reverberation time below 0.6 s is desirable for adequate speech intelligibility for sensitive groups.”
[Authors’ note: See also Section 3.51 of this Review]

22. Research by GP van den Berg, of the University of Groningen in the Netherlands, examines how wind turbine sound acts in the environment. In ‘The Beat is Getting Stronger: The Effect of Atmospheric Stability on Low Frequency Modulated Sound of Wind Turbines’ [*Journal of Low Frequency Noise, Vibration, and Active Control* 24(1), March 2005], van den Berg writes:
- a. *‘Our experience at distances of approximately 700 m to 1500 m from the Rhede Wind Farm, with the turbines rotating at high speed in a clear night and pronounced beating audible, is that the sound resembles distant pile driving. When asked to describe the sound of the turbines in this wind farm, a resident compares it to the surf on a rocky coast. Another resident near a set of smaller wind turbines, likens the sound to that of a racing rowing boat (where rowers simultaneously draw, also creating a periodic swish). Several residents near single wind turbines remark that the sound often changes to clapping, thumping or beating when night falls, like a washing machine.’* (p.14)
 - b. *‘Part of the relatively high annoyance level and the characterisation of wind turbine sound as lapping, swishing, clapping or beating may be explained by the increased fluctuations of the sound [2.21]. Our results in table 2 show that in a stable atmosphere measured fluctuation levels are 4 to 6 dB for single turbines, and in long term measurements (over many 5 minute periods) near the Rhede Wind Farm fluctuation levels of approximately 5 dB are common but may reach values up to 9 dB.’* (p.14)
 - c. *‘It can be concluded that, in a stable atmosphere, the fluctuations in modern wind turbine sound can be readily perceived. However, as yet it is not clear how this relates to possible annoyance. It can however be likened to the rhythmic beat of music: pleasant when the music is appreciated, but distinctly intrusive when the music is unwanted.’* (p.15).
 - d. *‘The hypothesis that these fluctuations are important, is supported by descriptions of the character of wind turbine sounds as ‘lapping’, ‘swishing’, ‘clapping’, ‘beating’, or ‘like the surf’.’*
 - e. *‘Those who visit a wind turbine in daytime will usually not hear this and probably not realise that the sound can be rather different in conditions that do not occur in daytime. This may add to the frustration of residents’. [See also Persson Waye et al, “Living close to wind turbines – a qualitative approach to a deeper understanding”] (p.15)*
 - f. *‘Fluctuations with peak levels of 3 – 9 dB above a constant level may have effects on sleep quality. The Dutch Health Council [‘Effects of Noise on Sleep and Health’, pub. No. 2004/14] states that ‘at a given L night value, the most unfavourable situation in terms of a particular direct biological effect of night-time noise is not, as might be supposed, one characterised by a few loud noise events per night. Rather, the worst scenario involves a number of noise events all of which are roughly 5 dB (A) above the threshold for the effect in question’. [emphasis added]*
 - g. *‘For transportation noise (road, rail, air traffic) the threshold for motility (movement), a direct biological effect having a negative impact on sleep quality, is a sound exposure level per sound event of SEL=40 dB (A) in the*

bedroom [Dutch Health Council]. The pulses in figure 6 have SEL-values up to 50 dB (A), but were measured on the façade. With an open window facing the wind turbines indoors SEL-values may exceed the threshold level.’ (p15)

23. GP van den Berg concludes:

- a. *‘Atmospheric stability has a significant effect on wind turbine sound, especially for modern tall turbines.’ (p 15)*
- b. *‘First, it is related to a change in wind profile causing strong, higher altitude winds, while at the same time wind close to the ground may become relatively weak. High sound immission levels may thus occur at low ambient sound levels, a fact that has not been recognised in noise assessments where a neutral or unstable atmosphere is usually implied. As a result, wind turbine sound that is masked by ambient wind-related sound in daytime, may not be masked at night time. [van den Berg GP. Effects of the wind profile at night on wind turbine sound. Journal of sound and vibration 2004; 277 (4-5): 955 – 970]*
- c. *Secondly, the change in wind profile causes a change in angle of attack on the turbine blades. This increases the thickness (infra) sound level as well as the level of trailing edge (TE) sound.*

‘The calculated rise in sound level during swish then increases from 1 – 2 dB to 4 – 6 dB. This value is confirmed by measurements at single turbines in the Rhede Wind Farm where maximum sound levels rise 4 to 6 dB above minimum sound levels within short periods of time.’ (p 15 – 16)

- d. *Third, van den Berg notes that ‘atmospheric stability involves a decrease in large scale turbulence ... As a result turbines in the farm are exposed to a more constant wind and rotate at a more similar speed with less fluctuations. Because of the near-synchronicity, blade swishes may arrive simultaneously for a period of time and increase swish level.*

Sound level differences ($L_{A\ max} - L_{A\ min}$) (corresponding to swish pulse heights) within 5 minute periods over long measurement periods near the Rhede Wind Farm show that level changes of approximately 5 dB occur for an appreciable amount of the time and may less often be as high as 8 to 9 dB. This level difference did not decrease with distance, but even increased 1dB when distance to the wind farm rose from 400 m to 1,500 m. The added 3 – 5 dB, relative to a single turbine, is in agreement with simultaneously arriving pulses from two or three approximately equally loud turbines.’ (p.16)

24. In 2001, Casella Stanger produced “Low frequency Noise”, a report for DEFRA (Technical Research Support for Defra Noise programme). Section 4 addresses the ‘Possible Effects of LFN’:

‘As with any noise, reported effects include annoyance, stress, irritation, unease, fatigue, headache, possible nausea and disturbed sleep.

Low frequency noise is sometimes confused with vibration. This is mainly due to the fact that certain parts of the human body can resonate at various frequencies. For example the chest wall can resonate at frequencies of about 50 to 100Hz and the head at 20 to 30Hz.’ [S.4.1]

25. In England, U.K., decision-makers are guided by the State according to Planning Policy Statement 22 (2004).

PPS 22 ‘Noise’ states:

*“The 1997 report by ETSU-R-97 for the Dti **should** be used to assess and rate noise from wind energy developments.”* [emphasis added]

(Note: “should” is not a command statement.)

26. There were 14 Members of the ETSU-R-97 Noise Working Group (NWG), including the Chairman from the Dti. Nearly 60% were either from Power companies involved in wind farm schemes, wind energy trade associations, or specialist advisors to wind farm developers. [Preface, p. i]

Indeed, the following statement appears in the introduction to ETSU-R-97:

“While the Dti facilitated the establishment of this Noise Working Group this report is not a report of Government and should not be thought of in any way as replacing the advice contained with relevant Government guidance.”

[Preface p.i]

27. ETSU-R-97 states in its Executive Summary that:

- a. *“This document describes a framework for the measurement of wind farm noise and gives indicative noise levels thought to offer a reasonable degree of protection to wind farm neighbours, **without placing unreasonable restrictions on wind farm development** or adding unduly to the costs and administration burdens on wind farm developers or local authorities.”* [emphasis added] [Summary S. 1]
- b. *“The NWG ... wind farms are usually sited in the more rural areas of the UK where enjoyment of the external environment can be as important as the environment within the home.”* (Summary S. 3)
- c. *“ The NWG considers that absolute noise limits applied at all wind speeds are not suited to wind farms in typical UK locations and that limits set relative to the background noise are more appropriate in the majority of cases.”* [Summary, S.8]
- d. *“The **recommendation** of the NWG is that, generally the noise limits should be set relative to the existing background noise at nearest noise-sensitive properties ... We have considered whether the low noise limits which this could imply in particularly quiet areas are appropriate and have concluded that it is not necessary to use a margin above background approach in such low-noise environments. **This would be unduly restrictive on developments ...**”* (emphasis added) [Summary S.11]
- e. *Separate noise limits should apply for day-time and for night-time. The reason for this is that during the night the protection of external amenity*

*becomes less important **and emphasis should be on preventing sleep disturbance.** Day-time noise limits will be derived from background noise data taken during quiet periods of the day and similarly the night-time limits will be derived from background noise data during the night”* (night-time is defined as 11pm-7pm)

- f. *“The NWG recommends that the fixed limit for night-time is 43 dB(A). This is derived from the 35 dB(A) sleep disturbance criteria referred to in PPG24. An allowance of 10 dB(A) has been made for attenuation through an open window (free-field to internal) and 2dB subtracted to account for the use of LA90.10min rather than LAeq.10min.”* [Summary S.23]
- g. *“Lower limit”*
Applying the margin above background approach to some of the very quiet areas in the UK would imply setting noise limits down to say 25 – 30 dB(A) based upon background levels perhaps as low as 20 – 25 dB(A).
Limits of this level would prove very restrictive on the development of wind energy. *As demonstrated below, it is not necessary to restrict wind turbine noise below certain lower fixed limits in order to provide reasonable degree of protection of the amenity.”* (emphasis added)

28. In contrast, two years after ETSU-R-97, the WHO *Guidelines for Community Noise 1999* set tighter maximum permitted levels for community noise, yet ETSU-R-97, page 20 refers to *“the WHO document Environmental Health Criteria 12 – WHO 1980(14)*. Clearly, ETSU-R-97 does not reflect the latest World Health Organisation *Guidelines for Community Noise*.

29. Independent experts researched and wrote the WHO *Guidelines for Community Noise 1999*. In brief, the *Guidelines* state:

“In these Guidelines for Community noise only guideline values are presented. These are essentially values for the onset of health effects from noise exposure.” (5th paragraph S. 4.1)

“For each environment and situation, the guideline values take into consideration the identified health effects and are set, based on the lower levels of noise that effect health (critical health effects). (6th paragraph S. 4.1)

“In dwellings the critical effects of noise are on sleep, annoyance and speech interference. To avoid sleep disturbance, indoor guideline values for bedrooms are 30 dB LAeq for continuous noise and 45dB LAmax for single sound events. Lower levels may be annoying, depending on the nature of the noise source....” (S 4.3.1 & see also S 3.3 sleep disturbance)

“Thus when assessing the effects of environmental noise on its people it is relevant to consider the importance of the background noise level, the number of events, and noise exposure level independently.” (3rd paragraph S 4.1)

“Most problems occur at lower frequencies, where most environmental noise sources produce relatively high sound pressure levels.” (S 2.6)

“If noise includes a large proportion of low-frequency components, values even lower than the guideline values will be needed, because low-frequency components in noise may increase the adverse effects considerably.” (S 4.3)

“More regular variations of sound pressure levels with time have been found to increase the annoying aspects of the noise. For example, noises that vary periodically to create a throbbing or pulsating sensation can be more disturbing than continuous noise. (Bradley 1994b). Research suggests that variations at about 4 per second are more disturbing (Zwicker 1989).” (3rd paragraph S 2.3.2)

*“At night sound pressure levels at the outside facade of the living spaces should not exceed 45 dB LAeq and 60 dB LAmax, so that people may sleep with bedroom windows open. These values have been obtained by **assuming** that the noise reduction from outside to inside with the window partly open is 15 dB.”*

30. It may seem that 15dB is a high level of attenuation through the external envelope especially for timber-framed buildings and high glazed areas. However, the guideline for the onset of sleep deprivation is 30dB, reduced if low frequency noise characters are present and further reduced if throbbing/pulsating characters are present – both of which are present for wind turbine noise. This lower figure represents a new base level to which is added the noise attenuation factor for the external envelope, with a window partially open, to give the outside façade level.

[Note: the 30dB max for a bedroom is a continuous maximum noise level, which is substantially different to the ETSU-R-97 guideline that allows 5dB above background noise.]

31. The importance of an ‘in the bedroom at night maximum level’ is emphasised by the findings of GP van den Berg. Van den Berg’s research reveals that [van den Berg GP. *Effects of the wind profile at night on wind turbine sound*. Journal of sound and vibration 2004; 277(4-5): 955-970]:

*‘Since the start of the operation of a 30 MW, 17 turbine wind park, residents living 500 m and more from the park have reacted strongly to the noise; residents up to 1900 m distance expressed annoyance. To assess actual sound immission, long term measurements (a total of over 400 night hours in 4 months) have been performed at 400 and 1500 m from the park. In the original sound assessment a fixed relation between wind speed at reference height (10 m) and hub height (98 m) had been used. **However, measurements show that the wind speed at hub height at night is up to 2.6 times higher than expected, causing a higher rotational speed of the wind turbines and consequentially up to 15 dB higher sound levels, relative to the same reference speed in daytime.** Moreover, especially at high rotational speeds the turbines produce a ‘thumping’, impulsive sound, increasing annoyance further. It is concluded that prediction of noise immission at night from (tall) wind turbines is underestimated when measurement data are used (implicitly) assuming a wind profile valid in daytime.’*

32. During stormy weather, the background wind noise sometimes disturbs sleep, but to suffer wind turbine noise in addition (as per ETSU-R-97) is likely to make sleep intermittent if not impossible.

*‘Many acoustical environments consist of sounds from more than one source. For these environments, **health effects are associated with the total noise exposure, rather than with the noise from a single source (WHO 1980b.)**’*
[WHO Guidelines for Community Noise 1999, S.3.8, The effects of combined noise sources]

33. In assessing how a level of below 30 dB is achieved (WHO S. 4.3.1 & S. 3.3), allowance must be made for a window to be open in order to provide ventilation, especially in warm weather. In addition, the sound reduction index of the external wall is only part of the consideration. The construction of the ceiling might only be a 15mm sheet of plaster, some thermal insulation (not sound insulation), a paper-thin vapour barrier, and thin roofing slate. The transmission **loss** through the ceiling or roof is slight.

‘The evidence on low-frequency noise is sufficiently strong to warrant immediate concern. Various industrial sources emit continuous low-frequency noise (compressors, pumps, diesel engines, fans, public works); and large aircraft, heavy duty vehicles and railway traffic produce intermittent low-frequency noise. Low-frequency noise may also produce vibrations and rattles as secondary effects. Health effects due to low-frequency components in noise are estimated to be more severe than for community noises in general (Berglund et al. 1996).’

‘Since A-weighting underestimates the sound pressure level of noise with low-frequency components, a better assessment of health effects would be to use C-weighting.’ [WHO Guidelines for Community Noise 1999, S.3.9, ‘The effects of combined noise sources’.]

*‘To protect the majority of people from being seriously annoyed during the daytime, the sound pressure level on balconies, terraces and outdoor living areas should not exceed 55 dB LAeq for a steady, continuous noise. To protect the majority of people from being moderately annoyed during the daytime, the outdoor sound pressure level should not exceed 50 dB LAeq. These values are based on annoyance studies, **but most countries in Europe have adopted 40dB LAeq as the maximum allowable level for new developments (Gottlob 1995). Indeed the lower level should be considered the maximum allowable sound pressure level for all new developments whenever feasible.**’ (WHO S.4.3.1.)*

34. It should be noted that:

- a The 30 dB LAeq is not variable with external weather conditions – it is a fixed level regardless of external weather conditions and external background noise.
- b The nature of the pulsating beat of the wind turbine, together with probable ground vibration, and the low frequency noise character, are clear reasons to support a lower level than 30 dB LAeq, especially at night.
- c WHO *Guidelines for Community Noise 1999* does not provide for measurements limited to background noise plus 5 dB as per ETSU-R-97, but clearly states that noise in a bedroom above 30 dB causes sleep disturbance.

- d It is possible to conceive of a position where a lightly constructed dwelling with minimal sound transmission loss between bedroom ceiling and the external wall is subjected to an external wall sound of 45 dBA at night. If the WHO 30dBA maximum bedroom level is applied but reduced to reflect the pulsating character and the low frequency character, the actual measurement inside the bedroom, with the window open for ventilation, will be only marginally less than 45 d BA, potentially creating a 15 dBA excess of sound **which is a staggering 30 fold difference in sound energy.** (See S. 4.18 & S. 4.40 of this review.)

35. The WHO Guidelines for Community Noise 1999 are shown on the following chart:

Table 1: Guideline values for community noise in specific environments:
WHO Guidelines for Community Noise 1999

Specific Environment	Critical Health Effects	LAeq [dB(A)]	Time Base [hours]	LAmx fast [dB]
Outdoor living area	Serious annoyance, daytime and evening Moderate annoyance, daytime and evening	55 50	16 16	- -
Dwelling, indoors Inside bedrooms	Speech intelligibility & moderate annoyance, daytime & evening Sleep disturbance, night-time	35 30	16 8	45
Outside bedrooms	Sleep disturbance, window open (outdoor values)	45	8	60
School classrooms & pre-schools, indoors	Speech intelligibility, disturbance of information extraction, message communication	35	during class	-
Pre-school bedrooms, indoor	Sleep disturbance	30	sleeping-time	45
School, playground outdoor	Annoyance (external source)	55	during play	-
Hospital, ward rooms, indoors	Sleep disturbance, night-time Sleep disturbance, daytime and evenings	30 30	8 16	40 -
Hospitals, treatment rooms, indoors	Interference with rest and recovery	as low as possible		

The WHO *Guidelines for Community Noise 1999* also examine the acoustic measurement of sound:

'The A – weighting (dBA) is most commonly used and is intended to approximate the frequency response to our hearing system ... C – weighting (dBC) is also quite common and is nearly a flat frequency response with the extreme high and low frequencies attenuated. When no frequency analysis is possible, the difference between A weighted and C weighted levels gives an indication of the amount of low frequency content in measured noise.' (WHO S.2.1.2)

*'Noise measures based solely on LAeq values do not adequately characterize most noise environments and do not adequately assess the health impacts of noise on human well-being. It is also important to measure the maximum noise level and the number of noise events when deriving guideline values. **If the noise includes a large proportion of low-frequency components, values even lower than the guideline values will be needed, because low-frequency components in noise may increase the adverse effects considerably.** When prominent low-frequency components are present, measures based on A-weighting are inappropriate. However, the difference between dBC (of dBlin) and dBA will give crude information about the presence of low-frequency components in noise. If the difference is more than 10 dB, it is recommended that a frequency analysis of the noise be performed.'* (WHO S.4.3)

36. In August 2006, the Dti (UK) published 'The Measurement of Low Frequency Noise at Three UK Wind Farms' [Report for Dti by Hayes McKenzie Partnership Ltd]. The report measured LFN at three wind farm sites in the UK, and although unidentified in the report, these sites are believed to be:

Site 1: Askam, Cumbria 7 x 0.66 MW wind turbines of 4.62 MW installed capacity, built 1999.

Site 2: Bears Down, Cornwall 16 x 0.6 MW of 9.62 MW installed capacity, built September 2001.

Site 3: Blaen Bowi, Carmarthenshire 3 x 1.3 MW of 3.9 MW installed capacity, built July 2002.

37. For the purpose of its Report, the Dti defined low frequency noise sources as between 20 – 250 Hz [S.1.3]. The Dti stated: *'Infrasound is noise at frequencies below the normal range of human hearing, i.e., less than 20 Hz.'* [S.1.2] The report stated that *'noise sources associated with these frequencies are generated by unsteady loading of the wind turbine blade.'*

Hubbard and Shepherd also make this observation. Their paper, 'Wind turbine acoustics' [NASA Technical Paper 3057, 1990, p 2496], considered three upwind and four downwind turbines. The upwind MODS.B and WWG-0600 machines measured between 60 dB – 70 dB below 20 Hz [p 2499; p 2502].

38. The Dti Report supports the Hubbard and Shepherd measurement of upwind machines:

‘Measurements of infrasound [below 20 Hz] in the vicinity of wind farms, and confirmed within this study, indicate typical sound pressure levels between 1 – 10 Hz of 60 – 80 dB, which falls well below the normal environmental infrasound levels experienced by all humans.’ [p 12]

39. The Dti Report observes:

‘The common cause of complaints associated with wind turbine noise at all three wind farms is not associated with low frequency noise, but is the audible modulation of the aerodynamic noise, especially at night.’ [p 3]

In the Report, the Dti does not provide evidence to support this statement as the sole cause of complaints. There is little doubt that audible modulation is a contributory cause, but as Professor James Lovelock, Professor Ralph Katz, Dr Amanda Harry, and Dr David Coley suggested, the “common cause” will be the acoustic radiation of sound characters of which a cocktail strikes the human body, the responses mainly being of a physiological (biologic/medical) nature, producing both short-term and long-term effects.

40. Section 2.10 of this Review noted several examples of public health concerns that emerged only after time, when a pattern of human exposure and adverse response could be observed, e.g., as reflected by the public health history with tobacco, mercury, asbestos, and thalidomide. It is therefore unsafe for the Dti to conclude that there is no environmental noise pollution from wind turbines without first conducting an independent acoustic and epidemiologic assessment.

41. The Dti Report uses the word “*perception*” and as this does not appear to be defined, one has to presume the authors are referring to “*perception of the auditory system*”, i.e., whether a sound is audible. The WHO *Guidelines for Community Noise 1999* states in S.2.1.6:

“Sound is a sensory perception evoked by physiological process in the auditory brain.” [That is, the process of ‘perceiving’ sound is a biologic/physiologic process.]

42. The Dti Report Conclusions [August 2006] state, on page 66:

“Community Noise, WHO ‘there is no reliable evidence that infrasound below the hearing threshold produce physiological or psychological effects.’”

The Dti report repeats this quotation on pages 2, 10, 46 and 66. However, this quotation is taken from the **WHO Community Noise Paper 1995 and does not appear in the final document of 1999.**

In fact, the WHO *Guidelines for Community Noise 1999* clearly states in Section 3.8:

“The evidence on low frequency noise is sufficiently strong to warrant immediate concern.”

“Health effects due to low frequency components in noise are estimated to be more severe than for community noises in general (Berglund et al 1996).”

43. Other conclusions of the Dti Report on page 66 include:

“Infrasound noise emissions from wind turbines are significantly below the recognised threshold of perception for acoustic energy within this frequency range.” (Below 20Hz)

There is significant medical evidence that infrasound is perceived by other organs in the human torso with negative health responses. (See Section 5, Health Effects, in this Review). The Dti Report measured at Site 2, Appendix 6C, levels of 40 – 50 dB between 10Hz-20Hz. The UKNA survey (S.4.52) measured 70dB below 20Hz on three wind farms. Both measurements are inaudible to the auditory brain (the ear), yet may medically have an impact on body organs.

44. Another conclusion from the Dti Report on page 66 states:

“It may therefore be concluded that infrasound associated with modern wind turbines is not a source which will result in noise levels which may be injurious to health of a wind farm neighbour.”

There is no substantive epidemiological or physiological evidence in the Dti Report to support this conclusion.

The Dti Report does not address the physiological or biological responses of the human body. Acousticians – with experience working as consultants to the wind industry – produced the Dti report, and as acousticians, they focus on acoustic analysis, identifying the sound power levels [dB] down to around the threshold of audibility.

45. The Dti Report considered the ‘individual thresholds of hearing’, observing that:

‘Measurements of the equal-loudness contours at frequencies below 20 Hz have been investigated by Moller and Andresen, and Whittle et al.’ (p. 26)

In a comparison of the results of these studies, the ‘measurements indicate good agreement between the two papers and indicate a continuing tendency for the contours to become closer as the frequency reduces. Therefore, in the infrasonic range, an increase of the sound pressure level by 10 dB may be perceived as an 8 – 16 fold increase in loudness as compared to a doubling, 2 fold increase at 1 kHz [1,000 Hz]. The result of this change in perceived loudness with change in sound pressure level in the low frequency region is that small changes in the pressure level may be experienced as a large change in perceived loudness.’ [emphasis added] [Moller H; Andresen J. Loudness of pure tones at low and infrasonic frequencies. Journal of low frequency noise and vibration 1984; 3(2): 78 – 87; and Whittle LS; Collins SJ; Robinson DW. The audibility of low frequency sounds. Journal of sound and vibration 1972; 21: 431 – 448]

‘Therefore, when infrasound and low frequency are of sufficient level to be detected, then a small change in pressure level above this threshold will quickly become perceived as a large change in loudness which may be considered unacceptable. The experience of the low frequency sufferers within the Salford Study [Proposed criteria for the assessment of low frequency noise disturbance. Report for Defra by Dr Andy Moorhouse et al, February 2005] indicated that once the subject has been ‘sensitised’ to low frequency noise, then only a small increase in pressure level above the hearing threshold is required to be considered unacceptable.’ [Dti S.3.3, p. 27]

46. The Dti Report compares the difference in sound power level (dB) at infrasound frequency, between downwind and upwind wind turbines:

‘Infrasound noise emissions were identified within a paper by Shepherd and Hubbard [Physical characteristics and perception of low frequency noise from wind turbines. Noise control engineering journal 1991 Jan/Feb; 36(1): 5 – 15] which provided field data from a number of upwind and downwind rotor configuration wind turbines. The generation of blade passage frequency (BPF) energy and associated harmonics were found to be more dominant for downwind rotor configurations. This was due to the effect of the supporting tower wake interaction as the blade passed behind the tower and would experience a sudden and significant change to the airflow.’ [Dti S.5, p 32]

However, if one refers to Hubbard and Shepherd’s ‘Aeroacoustics of Large Wind Turbines’ [JASA Journal of the Acoustical Society of America 1991, figure 8, p 2499], the upwind wind turbines show a similar noise spectra, indicating sound pressure levels (dB) between 60 – 70 dB in the 1Hz – 20 Hz range. This compares with the Dti Report on upwind machines of between 50 – 60 dB in the 6 – 20 Hz range.

47. The Dti Report refers to infrasound noise immissions:

‘The measured data indicates that wind turbines do increase the level of infrasound acoustic energy within the environment but that this energy is below the perception threshold.’ [Dti p 36]

While the Dti Report provides evidence to support the view that the sound pressure level (dB) when below 20 Hz is below the threshold of audibility, the report provides no evidence to support the view that the noise is below the threshold of human perception. Indeed, a purely acoustics report cannot provide evidence in that regard, because humans are physiologically affected by inaudible sound. Inaudible sound affects not only humans, but also animals; e.g., animals retreated from the coastal areas of the tsunami that devastated parts of Asia in 2004, and sonar can affect whales and dolphins. [Mott M. Did animals sense tsunami was coming? National Geographic News, 4 January 2005. See also Section 4.11 of this paper.]

48. In identifying complaints from the three wind turbine sites where measurements were taken, the Dti Report noted: (pages 56-57)

'In general, the occupants of Site 1: Location 1 and Site 3: Locations 1 & 2, have described wind farm noise as being most intrusive within the dwellings during the night-time or early morning periods. The occupants have also indicated that the amplitude modulation of the aerodynamic noise is a character that draws their attention to the noise and which makes it readily identifiable when heard within an internal living space. The levels of external noise when the wind farms were considered to give rise to audible noise within the dwellings and specifically identified by the occupants ranged as follows:

Site 1 Location 1: 38.5 – 41.0 dB LAeq 10 min : 36.3 – 38.7 LA90, 10 min

Site 2 Location 1: 37.5 – 40.2 dB LAeq 10 min : 36.2 – 38.1 LA90, 10 min

Site 3 Location 1: 40.4 – 45.5 dB LAeq 10 min : 39.0 – 39.8 LA90, 10 min

'Irrespective of the existing background noise level at the time of the measurements, the external noise levels associated with the operation of the wind turbines meet the requirements of ETSU-R-97 for night-time operations' – the greater of 43 dB LA90 (or background + 5 dB) – 'i.e., noise levels are lower than 43 dB LA90. This level provides protection against the awakening of an occupant, based upon the recordings, where no occupant was noted to awaken due to noise associated with the operation of the wind turbine.'

'Measured internal noise levels for the same measurement periods detailed above are as follows: (page 60)

Site 1 Location 1: 22.7 – 24.6 LAeq 10 min : 21.8 – 22.5 dB LA90, 10 min

Site 2 Location 1: 27.6 – 36.7 LAeq 10 min : 25.9 – 30.1 dB LA90, 10 min

Site 3 Location 1: 42.5 – 53.1 LAeq 10 min : 41.6 – 42.0 dB LA90, 10 min

Site 1, location 1 is within a double glazed conservatory with no windows open.

Site 2, location 1, is within a room with windows open.

Site 3, location 1, is within a room with windows open with the internal measurement location having a direct line of sight down to the stream in the valley below and the microphone placed within 0.3 m of the open window.'

[Authors' note: Compliance with the noise limits based on ETSU-R-97 does not imply that there will be no significant noise impact on local residents.]

49. The following are further examples of measurements forming part of the Dti report Appendix:

For example, Site 1, measurements taken on 16 May 2005, are within the frequency range of 10 Hz – 20 Hz, an L_{eq} dB of between 40 dB – 45 dB ‘Low frequency noise audibility external façade’, location 1:00:00 – 1:02:35 (figures 1 and 32).

For example, Site 2 measurements taken on 14 June 2006, ‘Low frequency noise audibility internal before windows open’, an L_{eq} dB within the frequency range of 10 Hz – 20 Hz of between 40 – 45 dB was measured, Location 1:21:00 – 1:21:15 (figures 1 and 4).

50. This, however, portrays just a small part of the picture. To be useful, all wind turbine acoustic measurements should include the following information. This is because the rotation speed of the blades can be controlled remotely, especially when a noise management scheme is in place. The rotation speed (rpm) has a direct bearing on the noise emission from the wind turbine.

- i. Distance of the measured point from nearest wind turbine;
- ii. Measured point relative to the wind turbines (array impact);
- iii. Wind speed and direction at the hub height;
- iv. Actual revolutions per minute of the blades at the time of measurement – as this does not necessarily correlate to wind speed;
- v. Difference in altitude between the measured point and the wind turbine;
- vi. A definitive description of the terrain; and
- vii. A dB(A) and dB(C) measurement of frequency down to 1 Hz.

51. Referring to Site 1, the Dti report [p 81] comments:

*‘It should be noted that the description of the noise by the awoken occupant was that the noise was “intolerable”. The range in levels in the 400 – 500 Hz third octave bands was measured to lie between 9 – 10 dB and to be 17 dB above the B.S. ISO 226:2003 Threshold Criterion Curve. In this event, **the perceived change in level in this frequency range would be a doubling of the perceived loudness, with levels potentially rising in and out of the Threshold of Audibility.** [emphasis added] This would give rise to a sound of a muffled swish that could be described as a heart beat type sound as the sound may only be audible for part of the time, i.e., as the noise associated with the wind farm is aerodynamic in origin and is associated with the rotation of the blades, then this will appear at 3 times the rotational speed also known as the blade passage frequency (bpf). The turbines operate with a rotational speed of 26 rpm, which equates to a blade passage frequency = 78 bpf. This is in the normal range of a heart beat.’ [p 81]*

According to ‘Measuring Sound’, a publication from Bruel and Kjaer, a company that manufactures acoustical measuring and calibrating equipment used by many researchers and industries, when noise levels are too high and no other means of attenuation has worked or is feasible, then:

‘Shut down the offending machinery. In severe cases, this step must be considered. It is also possible to limit the hours of operation.’
[Bruel and Kjaer. Measuring Sound, September 1984 (rev)]

52. In August 2006, the United Kingdom Noise Association (UKNA) published a report by John Stewart, ***'Location, Location, Location'***. This report, believed to be the first produced with input and evidence from both acoustic and medical resources and experts, addresses the cause of the suffering of families when wind turbines have been built too close to their homes:

'Our own conclusion, after reviewing the evidence ... So much depends on the location of the wind farm relative to where people live.'

The UK Noise Association measured noise levels around three wind farms: Bears Down (October 2005) in Cornwall; Bradworthy (December 2005) in Devon; and Blaen Bowi (October 2005) in Wales. (As previously mentioned it is believed that the Dti took its measurements at Bears Down– its Site 2; and Blaen Bowi – its Site 3.)

53. UKNA summarised its findings of wind turbine noise measured outdoors:

'At 10 Hz, the noise from the wind farms ranged from negligible (upwind from the turbines) to 75 dB (C) (downwind). Because 'Watanabe and Moller' figures are 'G' weighted and the UK Noise Association used 'C' weighting, only approximate comparisons are possible. But these findings are well within the 97 decibels where it would become a noise problem at 10 Hz, whatever the weighting.'

'At 20 Hz, the noise from the wind farms ranged from a low of 10 dB (C) (upwind of the turbines) to a high 82 dB (C) (downwind), with the great majority of the results falling in the 40 – 70 dB (C) range.' [p 14]

54. UKNA also tested for low frequency noise indoors. A house close to the Blaen Bowi wind farm was used (p 15):

"The results we obtained were these:

'At 10 Hz, the noise levels ranged from 44 to 48 decibels, well below the levels at which the noise could be heard. At 20 Hz, the noise levels ranged from 40 to 48 decibels, again well below audible levels. At 60 Hz, the noise levels ranged from 44 to 63 decibels, which suggests that low-frequency noise is being heard at times. At 100 Hz, the decibel levels ranged from 42 to 52 decibels, which indicates that the 'swish' sound is being heard, containing low frequency content.' "

55. The UKNA Report also stated:

On page 19: *'Conclusions on Noise and Health.*

Pedersen's arguments are persuasive that the dancing shadows and the rotating blades can significantly add to the annoyance and stress caused by noise from the turbines. The questions being asked by some in the medical profession as to whether this cocktail of effects – the noise, low frequency, rotating blades, the shadows and the strobing – is leading to ill health out of proportion to the noise turbines make, needs serious examination.'

On page 20 - first conclusion: *'Overall Conclusions.*

1. Wind farm noise, in common with noise generally, affects different people in different ways, but the evidence suggests there is rarely a problem for people living more than 1 – 1.5 miles from a turbine.'

On page 21- first recommendation. *'Overall Recommendations.*

It would be prudent that no wind turbine should be sited closer than 1 mile away from the nearest dwelling. This is the distance the Academy of Medicine in Paris is recommending, certainly for the larger turbines and until further studies are carried out. There may even be occasions where a mile is insufficient depending on the scale and nature of the proposed development.'

56. The following charts from the UKNA survey confirm the presence of LFN. Using the WHO alternative measure (*Guidelines for Community Noise 1999, S 2.1.2*), "when no frequency analysis is possible, the difference between A-weighted and C-weighted levels gives an indication of the amount of low frequency content in the measured noise." The difference in two sample readings at Bradworthy (005 & 007), between A and C weighting was 29 and 30 decibels; at Bears Down (05 & 06), the difference was between 25 and 30 decibels; and at Blaen Bowi (005 & 006), the difference was between 26 and 27 decibels.

BRADWORTHY 05

Wind Direction SW speed 9 – 19 MPH Shielded from Wind

Location Hillside Farm SS 294 135

Microphone – 1Hz

Shielded from Direct Wind

Instrument: 2250
 Application: BZ7223 Version 1.2
 Start Time: 07/12/2005 19:53:13
 End Time: 07/12/2005 19:56:20
 Elapsed Time: 00:03:07
 Bandwidth: 1/3-octave
 Max Input Level: 140.50

Time Frequency
 Broadband (excl. Peak): FSI AC
 Broadband Peak: C
 Spectrum: FS C

Instrument Serial Number: 2505941
 Microphone Serial Number: 2508682
 Input: Top Socket
 Windscreen Correction: None
 Sound Field Correction: Free-field

Calibration Time: 07/12/2005 14:47:11
 Calibration Type: External reference
 Sensitivity: 52.78 mV/Pa

Brad005 Text

	Start time	End time	Elapsed time	Overload [%]	LAFeq [dB]	LAFmax [dB]	LAFmin [dB]
Value				0.00	47.7	56.9	41.9
Time	19:53:13	19:56:20	0:03:07				
Date	07/12/2005	07/12/2005					

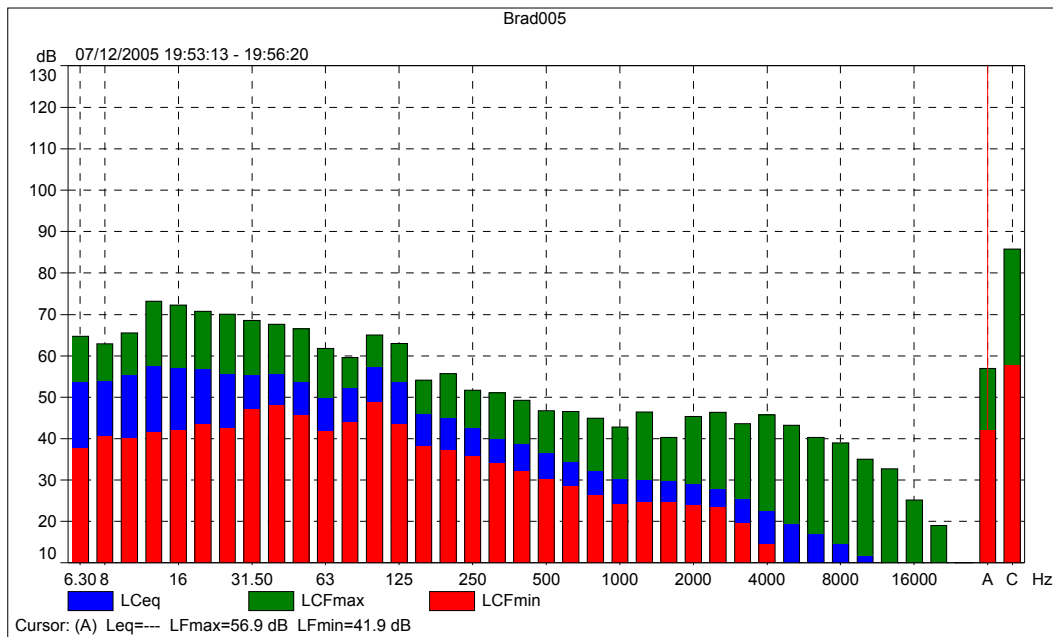

BRADWORTHY 07
from Wind

Wind Direction NW speed 9 – 23 MPH

Shielded

Location SS 304 135

Microphone – Normal

Audio File – Track Brad02

Instrument: 2250
 Application: BZ7223 Version 1.2
 Start Time: 08/12/2005 11:19:27
 End Time: 08/12/2005 11:24:07
 Elapsed Time: 00:04:40
 Bandwidth: 1/3-octave
 Max Input Level: 141.24

	Time	Frequency
Broadband (excl. Peak):	FSI	AC
Broadband Peak:	C	
Spectrum:	FS	C

Instrument Serial Number: 2505941
 Microphone Serial Number: 2508682
 Input: Top Socket
 Windscreen Correction: UA 1650
 Sound Field Correction: Free-field

Calibration Time: 08/12/2005 09:45:31
 Calibration Type: External reference
 Sensitivity: 48.41 mV/Pa

Brad007 Text

	Start time	End time	Elapsed time	Overload [%]	LAFeq [dB]	LAFmax [dB]	LAFmin [dB]
Value				0.00	49.5	63.8	39.1
Time	11:19:27	11:24:07	0:04:40				
Date	08/12/2005	08/12/2005					

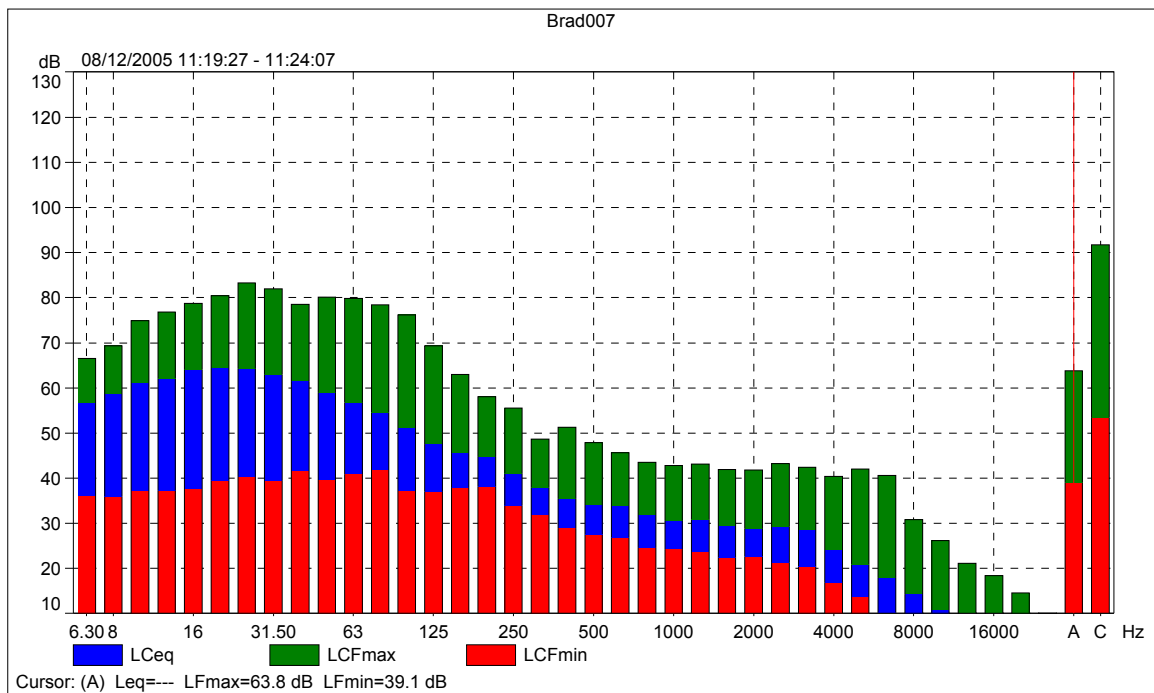

BEARSDOWN 05

Location SH 904 685

Wind Speed 12 – 15 MPH

Wind Direction S

Microphone Normal

Instrument: 2250
 Application: BZ7223 Version 1.2
 Start Time: 07/12/2005 15:22:25
 End Time: 07/12/2005 15:24:27
 Elapsed Time: 00:02:02
 Bandwidth: 1/3-octave
 Max Input Level: 140.50

Time Frequency
 Broadband (excl. Peak): FSI AC
 Broadband Peak: C
 Spectrum: FS C

Instrument Serial Number: 2505941
 Microphone Serial Number: 2508682
 Input: Top Socket
 Windscreen Correction: None
 Sound Field Correction: Free-field

Calibration Time: 07/12/2005 14:47:11
 Calibration Type: External reference
 Sensitivity: 52.78 mV/Pa

Bearsdown05 Text

	Start time	End time	Elapsed time	Overload [%]	LAFeq [dB]	LAFmax [dB]	LAFmin [dB]
Value				0.00	52.6	58.9	45.1
Time	15:22:25	15:24:27	0:02:02				
Date	07/12/2005	07/12/2005					

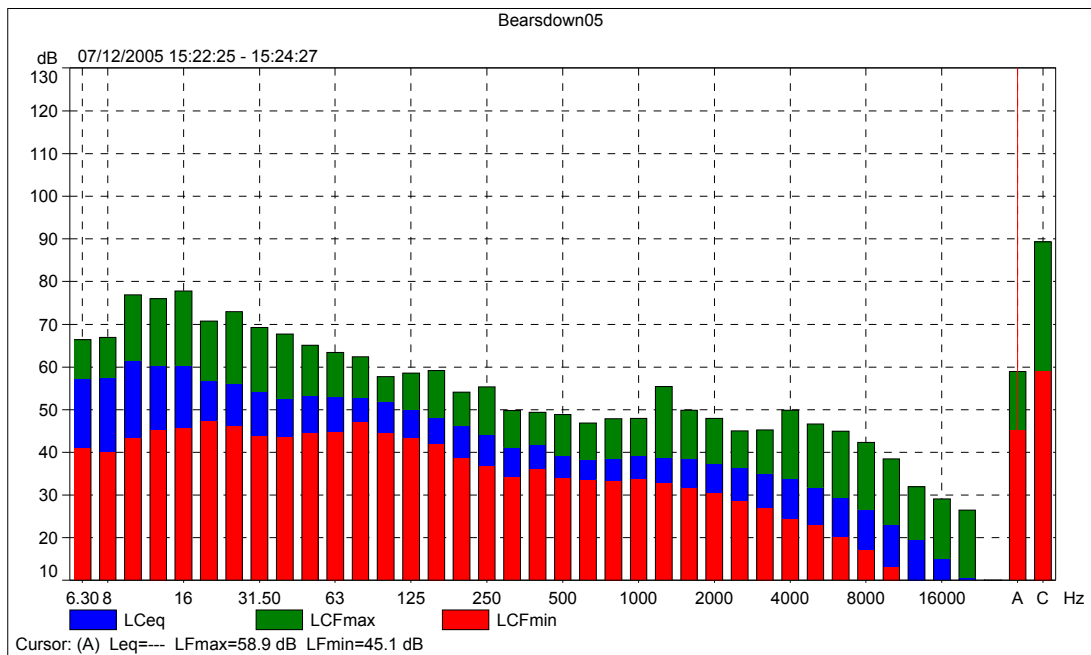

BEARSDOWN 06

Location

SH 904 685

Wind Speed 10 – 18 MPH

Wind Direction S

Microphone 1 Hz

Instrument: 2250
 Application: BZ7223 Version 1.2
 Start Time: 07/12/2005 15:26:33
 End Time: 07/12/2005 15:28:39
 Elapsed Time: 00:02:06
 Bandwidth: 1/3-octave
 Max Input Level: 140.50

Time Frequency
 Broadband (excl. Peak): FSI AC
 Broadband Peak: C
 Spectrum: FS C

Instrument Serial Number: 2505941
 Microphone Serial Number: 2508682
 Input: Top Socket
 Windscreen Correction: None
 Sound Field Correction: Free-field

Calibration Time: 07/12/2005 14:47:11
 Calibration Type: External reference
 Sensitivity: 52.78 mV/Pa

Bearsdown06 Text

	Start time	End time	Elapsed time	Overload [%]	LAFeq [dB]	LAFmax [dB]	LAFmin [dB]
Value				0.00	57.2	64.8	49.4
Time	15:26:33	15:28:39	0:02:06				
Date	07/12/2005	07/12/2005					

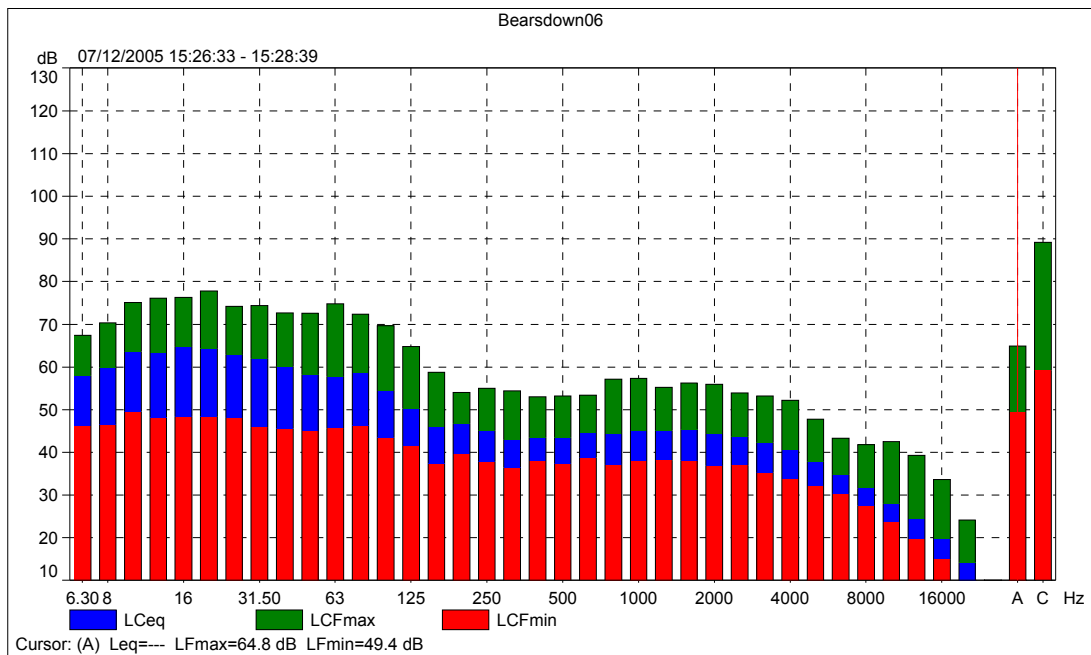

BLAEN BOWI 005

No Filter Installed Location SN 32314 BNG 36829

Instrument: 2250
 Application: BZ7223 Version 1.2
 Start Time: 01/12/2005 11:55:22
 End Time: 01/12/2005 11:57:32
 Elapsed Time: 00:02:10
 Bandwidth: 1/3-octave
 Max Input Level: 140.67

Time Frequency
 Broadband (excl. Peak): FSI AC
 Broadband Peak: C
 Spectrum: FS C

Instrument Serial Number: 2505941
 Microphone Serial Number: 2508682
 Input: Top Socket
 Windscreen Correction: UA 1650
 Sound Field Correction: Free-field

Calibration Time: 01/12/2005 10:12:59
 Calibration Type: External reference
 Sensitivity: 51.65 mV/Pa

BlaenBow006 Text

	Start time	End time	Elapsed time	Overload [%]	LAFeq [dB]	LAFmax [dB]	LAFmin [dB]
Value				0.00	65.4	71.8	57.1
Time	11:55:22	11:57:32	0:02:10				
Date	01/12/2005	01/12/2005					

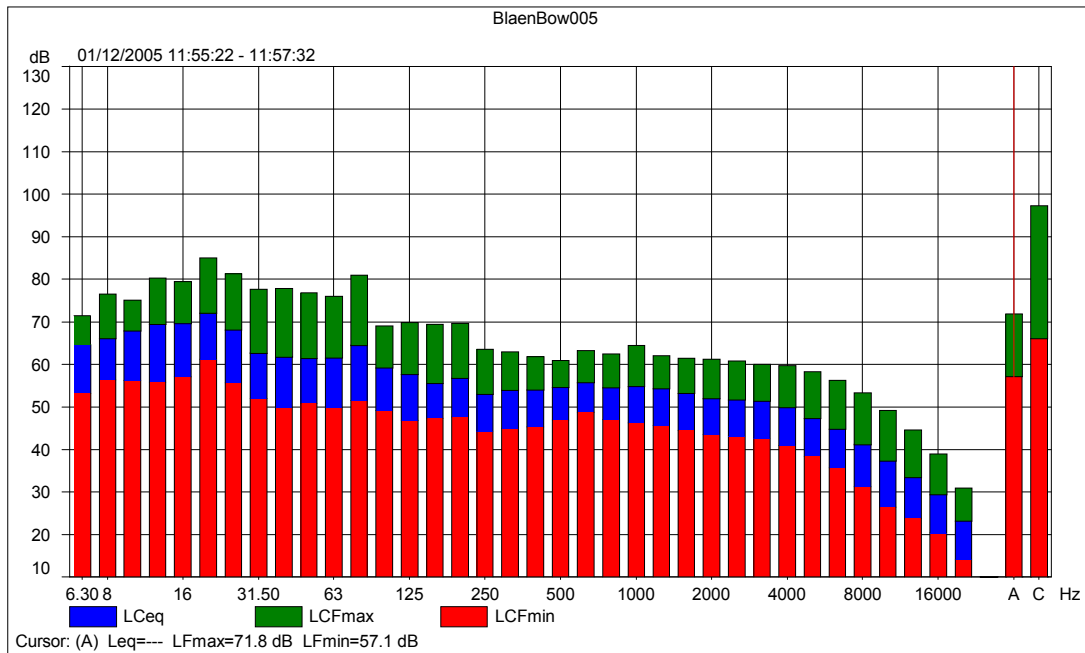

BLAEN BOWI 006

Location SN 33081 BNG 35867

Wind Speed 17 – 24 mph

Instrument: 2250
 Application: BZ7223 Version 1.2
 Start Time: 01/12/2005 11:55:22
 End Time: 01/12/2005 11:57:32
 Elapsed Time: 00:02:10
 Bandwidth: 1/3-octave
 Max Input Level: 140.67

Time Frequency
 Broadband (excl. Peak): FSI AC
 Broadband Peak: C
 Spectrum: FS C

Instrument Serial Number: 2505941
 Microphone Serial Number: 2508682
 Input: Top Socket
 Windscreen Correction: UA 1650
 Sound Field Correction: Free-field

Calibration Time: 01/12/2005 10:12:59
 Calibration Type: External reference
 Sensitivity: 51.65 mV/Pa

BlaenBow006 Text

	Start time	End time	Elapsed time	Overload [%]	LAAeq [dB]	LAFmax [dB]	LAFmin [dB]
Value				0.00	65.4	71.8	57.1
Time	11:55:22	11:57:32	0:02:10				
Date	01/12/2005	01/12/2005					

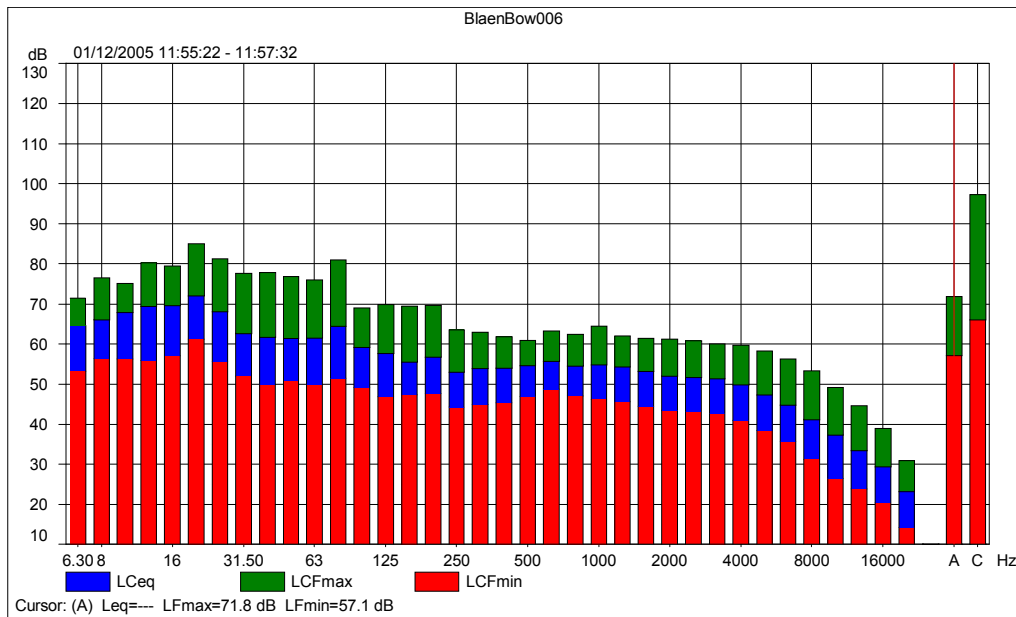

57. The following chart is an analysis of low frequency noise from a DAT tape prepared by Delta, consultants for 'Bonus' of a Bonus 1.3MW wind turbine. The chart formed part of "A Report to Vale of the White Horse District Council"(UK) by Dr G Leventhall, March 2004:

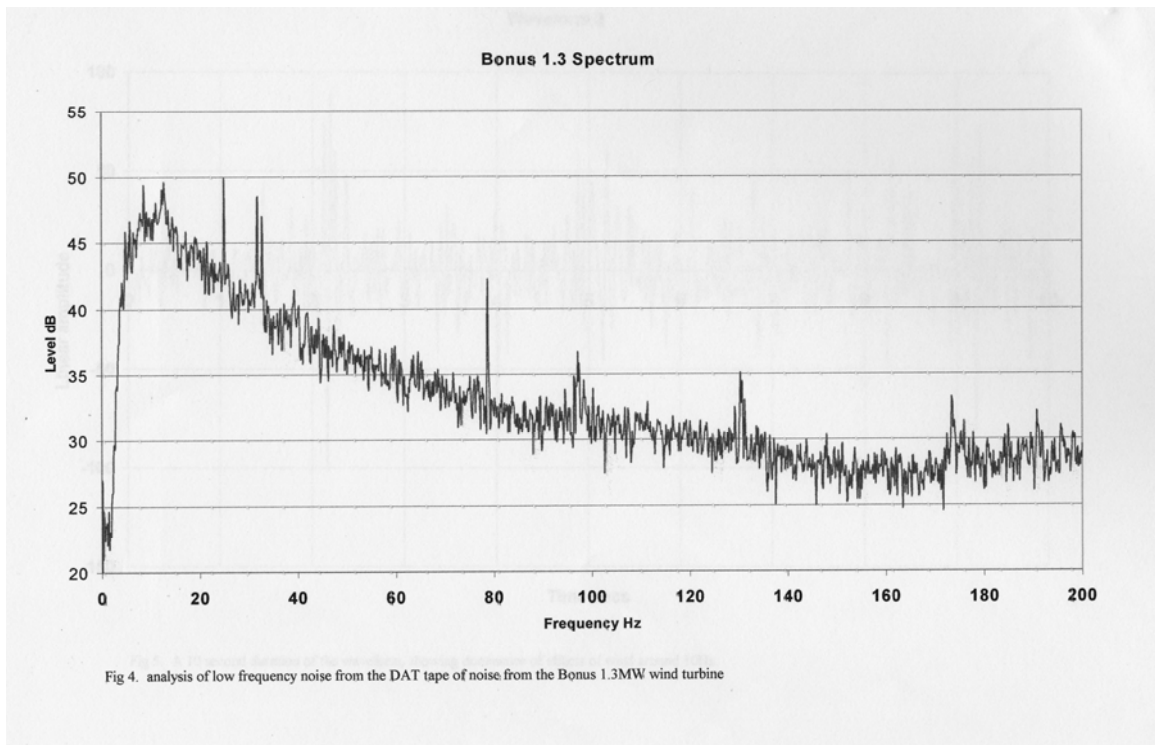

It is significant that the noise measurements taken by UKNA correlate with the noise chart in the low frequency noise range, of the Bonus 1.3 MW wind turbine. However, the fall-off at 0Hz – 6Hz is a surprise and may be due to the instrumentation.

58. In a recent publication [Leventhall G. Infrasound from wind turbines – fact, fiction and deception. Canadian acoustics 2006 Jun; 34(2): 29 – 36], Geoffrey Leventhall, acoustician and consultant to Defra and Dti, writes that:

'Infrasound from wind turbines is below the audible threshold and of no consequence.'

However, Leventhall does acknowledge that wind turbine noise can be problematic:

'Low frequency noise is normally not a problem, except under conditions of unusually turbulent inflow air.'

'Turbulent air inflow conditions cause enhanced levels of low frequency noise, which may be disturbing, but the overriding noise from wind turbines is the fluctuating audible swish ...'

A wind turbines' main noise source is produced by the 'repeating sound of the blades interacting with the tower. This is the noise which requires attention, both to reduce it and to develop optimum assessment methods.' [See also section 4.19 of this paper: Report by Styles et al; report by the US Department of Defense]

59. The suitability of using ETSU-R-97 as a guide for reasonableness is challenged by Dick Bowdler in *'ETSU-R-97: Why it is Wrong'* [July 2005]. The Bowdler Report comments:

On page 61 of ETSU-R-97, the Noise Working Group stated that:

'During the night one can reasonably expect most people to be indoors and it will not be necessary to control noise to levels below those required to ensure that the restorative process of sleep is not disturbed. A night-time absolute lower limit is therefore appropriate based upon sleep disturbance criteria.' [ETSU-R-97]

Bowdler counters this assumption by the Noise Working Group [NWG] with the following:

'What this says is that a turbine noise level inside peoples' houses of just less than the World Health Organisation say is necessary to get back to sleep if you wake up in the night is satisfactory. It seems to me this must be the very upper limit of acceptability, not one that is well balanced. Since then, the WHO has revised its guidance 5 dB lower. So the ETSU night standard is now higher than WHO say you need to get back to sleep.' [Bowdler, 3.15]

60. On page 62 of ETSU-R-97, the NWG wrote:

'It is also the opinion of the Noise Working Group that there is no need to restrict noise levels below a lower absolute limit of LA90, 10min = 33db(A); if an environment is quiet enough so as not to disturb the process of falling asleep or sleep itself then it ought to be quiet enough for the peaceful enjoyment of one's patio or garden.' [ETSU-R-97]

Again, this conclusion relies on presumption; Bowdler responds:

'This is a bizarre statement. It seems that the 33dBA is the 35dB sleep restoration level set out by the World Health Organisation for inside bedrooms at night. They seem to be saying that there is no need for noise levels during the day to be any lower than is necessary to allow you to go to sleep on your patio on a sunny afternoon.' [Bowdler, 3.16]

*'Having suggested that 33dB would be satisfactory because people could get to sleep on their patio – they now say that "This level would however be a damaging constraint on the development of wind power in the UK as the large separation distances required to achieve such low noise levels would rule out most potential wind farm sites" [ETSU-R-97]. There is absolutely no evidence brought forward to justify this. **A margin of 2km would normally easily achieve this even with the noisier modern turbines.** They argue that "Wind farms have global environmental benefits which have to be weighed carefully against the local environment impact" [ETSU-R-97]. So do many other things. They argue that "Wind farms do not operate on still days when the more inactive pastimes (e.g. sunbathing) are likely to take place" [ETSU-R-97]. The suggestion seems to be that the protection of*

people's amenity does not include protecting them whilst sunbathing in their gardens on a slightly windy day or sleeping on the patio.' [Bowdler, 3.17]

*'Then, on page 63 [of ETSU-R-97] there is another leap of credibility: "There is no evidence for or against the assertion that wind farm noise with no audible tones is acceptable up to and including LA90, 10min levels of 40dB(A) even when background noise levels are 30dB or less". This is just nonsense. There most certainly is evidence against this assertion. The 40dB is actually 42dB in BS4142 units. This is at least 12dB above background noise level of "30dB or less" and BS4142 says there are likely to be complaints at turbine levels of plus 10dB. Furthermore there is no argument that BS4142 is not applicable. Even BS4142:1990 (which was current when ETSU-R-97 was written) might easily be applicable here. If the wind speed is 5m/s, the background noise 30dB and the turbine noise 42dB(LAeq) then there is no reason not to use BS4142, it does not exclude itself in these circumstances. **This noise level is also 12dB more than (twice as loud as) the WHO considers necessary for you to be able to get to sleep.'*** [Bowdler, 3.18]

61. In August 2005, the Renewable Energy Foundation (REF) released a statement that commented on the new report by GP van den Berg, *"The beat is getting stronger: the effect of atmospheric stability on low frequency modulated sound of wind turbines"* [Journal of Low Frequency Noise and Vibration 2005; 24:1-24].

Prof. Ffowcs-Williams, Emeritus Professor of Engineering, Cambridge University, one of the UK's leading acoustical experts and an advisor to REF said [REF Studies on wind turbine noise raise further concerns, 4 August 2005]:

'Van den Berg's paper adds weight to the criticisms frequently offered of the UK regulations covering wind turbine noise, ETSU-R-97. The regulations are dated and in other ways inadequate. It is known that modern, very tall turbines, do cause problems, and many think the current guidelines fail adequately to protect the public.'

62. "Wind Energy" (published by John Wiley & Sons), a technical bimonthly journal of wind turbine engineering papers, provides evidence that confirms just how imprecise the forecasting of wind turbine performance is:

- a *"Challenges in modelling the unsteady Aerodynamics of wind turbines"* by JG Leishman, Department of Aerospace Engineering, University of Maryland (USA) [Wind Energy 2002;5;85-132]:

"Such problems include the challenges in understanding and predicting the unsteady blade airloads and rotor performance, as well as predicting the dynamic stresses and aeroelastic response of the blades. Wind turbines are also subjected to complicated environmental effects such as atmospheric turbulence, ground boundary layer effects, directional and spatial variations in wind shear, thermal stratification, and the possible effects of an upstream unsteady, bluff body-like wake from support structure (tower shadow).

*Fig. 1 [in original document] summarises the various aerodynamic sources that may affect air loads on a wind turbine, which can be decomposed into a variety of mostly periodic and mostly periodic contributions. **The net effect***

is that the wind turbine operates in an adverse unsteady aerodynamic environment that is both hard to define using measurements and also to predict using mathematical models.”

- b “Survey of modelling methods for wind turbine wakes and wind farms” by A Crespo, J Hernandez, and S Frandsen [Wind Energy 1999;2;1-24]:

“The final report (intensified study of wake effects behind single turbines and in wind power wakes, National Power, London), indicates that the experimental and analytical studies reported (annex) point to significant energy losses in arrays spaced at less than seven turbine diameters. Similarly, turbulence may increase in arrays, sufficiently to cause measurable damage to fatigue and dynamic loads.”

[Comment: In these circumstances, noise characters become more clearly pronounced.]

63. Morris et al further explain the difficulties [Morris PJ; Long LN; Brentner KS. An aeroacoustic analysis of wind turbines. American Institute of Aeronautics and Astronautics: AIAA-2004-1184; 42nd AIAA Aerospace Sciences Meeting, 5-8 January 2004, Reno, Nevada, 2004]:

‘Since the wind turbine noise problem is very challenging, only some of the important noise sources and mechanisms are being considered [in this particular study]. These are airfoil self-noise, the effects of blade rotation, and the propagation of sound over large distances.’

Their research encompasses ‘two aspects of airfoil self-noise ... The first is the relatively low frequency noise generated by deep stall and the second is trailing edge noise. The noise associated with blade rotation includes the effects of blade rotation on the blade aerodynamics, incoming gusts, incoming atmospheric turbulence and wind shear.’

The authors add that:

‘Wind turbines have aerodynamic and aeroacoustic behaviors with unique characteristics that make their prediction more challenging in many ways than already complicated aeroacoustic problems such as rotorcraft or propeller noise.’

Some of the challenges are due to the unpredictable and sudden changes in *‘blade / inflow / tower wake interactions.’* Moreover, wind turbine flows are complex, moving through *‘a varying atmosphere over an irregular terrain’,* with *‘the blade speed varies linearly from root to tip’*:

‘It would be unrealistic to suggest that all aspects of the wind turbine noise problem could be simulated within the framework of a single aerodynamics/ aeroacoustics code. The computational resources required to perform such a simulation will remain beyond the capabilities of available computers for many years.’

(Note: Interestingly, Morris et al use the permeable surface Ffowcs Williams-Hawkings formulation to couple unsteady flow simulations to the radiated noise

field; see item 61 of this section, Acoustics, for Professor Ffowcs Williams's comments on ETSU-R-97.)

The authors further note that:

'While discrete frequency noise is certainly an important component of wind turbine noise (especially at low frequencies), broadband noise sources are also very important (especially at the higher frequencies).'

Additionally:

'However, the sound generated by wind turbines, particularly the low frequency components, may propagate large distances through an unsteady, non-uniform atmosphere over an irregular terrain. Atmospheric absorption can also be significant for the high frequency noise components. Thus, for wind turbine applications, sound propagation is an important component of the complete aeroacoustic problem.'

64. Sezer-Uzol and Long concur with Morris et al and observe that:

'... the acceptance of wind turbines by the public depends strongly on achieving low noise levels in application ... Furthermore, the acoustic propagation is of interest at relatively large distances from the wind turbine.' [Sezer-Uzol N; Long LN. 3-D time-accurate CFD simulations of wind turbine rotor flow fields. American Institute of Aeronautics and Astronautics: AIAA Paper No. 2006-0394, 2006; CFD = Computational Fluid Dynamics]

65. If the measure for setting a noise standard lacks credibility to many professionals, it is understandable why it lacks credibility to those suffering adverse health consequences. If the methodology is inadequate, then an impartial team of experts should redesign the measure. Moreover, until there are newly defined measures that conclusively work beyond reasonable doubt, the old measure should be withdrawn from use immediately and **an immediate minimum 2km zone placed between people's homes and wind turbines**. Greater separation may be necessary in specific circumstances or with a wind turbine of greater than 2MW installed capacity.

66. Moreover, as Paul Schomer noted in 2002 [Schomer PD. For purposes of environmental noise assessment, A-weighting needs to be retired. JASA Journal of the acoustical society of America 2002 Nov; 112(5, pt 2): 2412]:

'... for the purposes of environmental noise assessment, A-weighting needs to be retired ... A-weighting fails to properly assess multiple noise sources ... and it fails to properly assess sound with strong low-frequency content. It performs better outdoors than indoors even though the receivers are indoors. It certainly cannot be used for room noise criteria. A-weighted Leq cannot assess the audibility of sound, and in fact, Leq in fractional octave bands cannot be used to assess the audibility of sounds at low frequencies.'

[See also WHO *Guidelines for Community Noise 1999*, s.1.2 & s.3.9]

Schomer continues:

'There are better measures for all of these functions such as loudness-level rating using ISO 226. At low frequencies, data show some people (about one-third) are "C-weighted" listeners. For all noise, it may be that one model just does not fit all. Experiments show that a majority of listeners make categorical judgments and merely count events based on level with the minority of subjects fitting three other models. There are many ways to clearly move forward but we must give up our A-weighting, it has now reached old age.'

67. According to Berglund et al [Berglund B; Hassmen P; Soames Job RF. Sources and effects of low-frequency noise. JASA Journal of the acoustical society of America 1996 May; 99(5): 2985 – 3002]:

'Low frequency noise is common ... as an emission from many artificial sources: road vehicles, aircraft, industrial machinery, artillery and mining explosions, and air movement machinery including wind turbines, compressors, and ventilation or air-conditioning units. The effects of low-frequency noise are of particular concern because of its pervasiveness to numerous sources, efficient propagation, and reduced efficacy of many structures (dwellings, walls, and hearing protection) in attenuating low-frequency noise compared with other noise ... Although the effects of lower intensities of low-frequency noise are difficult to establish for methodological reasons, evidence suggests that a number of adverse effects of noise in general arise from exposure to low-frequency noise ... [p 2985]

... standards should consider the option of allowing less noise in the low-frequency range since the possibility exists that a stimulus may have an effect even without conscious (auditory) detection. Definitive solutions to these problems would require unethical exposures to low-frequency noise ... The balance of probability would appear to favour the conclusion that low-frequency noise has a variety of adverse effects on humans, both physiological and psychological ... The evidence provided ... warrants concerned action without the potentially extremely lengthy delay that may be occasioned by waiting for definitive proof which may never arise. [p 2998]

- 68 Noise from wind turbines combines with visual phenomena such as shadow flicker, which compounds the adverse impact on those living nearby. R Bolton, who is president of a company that develops engineering software, observes in his report on shadow flicker:
[Bolton R. Evaluation of Environmental Shadow Flicker Analysis for "Dutch Hill Wind Power Project". Environmental Compliance Alliance, New York, USA, 30 January 2007]

'Large scale shadow flicker is a new phenomenon, not experienced by people on an "industrial scale", with football field sized shadows moving across their home or through their local views. As a new source of environmental pollution extra care is needed when evaluating the long term consequences.'

For example, on elevated ridges with wind turbines that are 400 feet high, the turbines *'will cast shadows for thousands of feet, well above any vegetative screening'*.

Shadow flicker is not only a day-time phenomenon; night-time flicker is also problematic. Conditions for shadow flicker include moon-lit nights, with the rising and setting of the moon. Moreover, ridgeline wind turbines can cast shadows that *'easily extend 2 to 4 miles'*:

'Residents and passers-by (highway traffic) not immediately within the shadow will nevertheless readily observe the shadow flicker ...'

'Often numerous wind turbines are sited linearly if placed on a ridgeline and nearby residents will be exposed to numerous shadow flickers simultaneously.'

That is, all three blades of each wind turbine will create flicker, and the flicker from all the wind turbines will not be synchronised.

According to the UK's Planning Guide for Renewable Energy: a companion guide to PPS22 (2004), *'flicker effects have been proven to occur only within ten rotor diameters of a turbine'*. Meridian Energy, a wind farm developer, recommends that *the 'nearest affected receptors' to a wind turbine producing shadow flicker, 'should be no closer than 10 turbine rotor diameters'*.

For a wind turbine with a 300-foot rotor diameter, the nearest receptor to shadow flicker should be no closer than 3000 feet.

In New York State (USA), the Department of Environmental Conservation Program Policy provides guidance for the phenomenon of shadow flicker:

'A properly sited and designed project is the best way to mitigate potential impacts.'

The guidance specifies that:

'It is the burden of the applicant to provide clear and convincing evidence that the proposed design does not diminish the public enjoyment and appreciation of the qualities of the listed aesthetic resource.'

Recognising the impact of shadow flicker, the Swedish building authority introduced a rule that the calculation of shadow flicker should be made for the building lot (garden), instead of only the window of a façade.

Bolton concludes that:

'... shadow flicker is a serious environmental pollutant that can have significant harmful effects on the welfare of persons subjected to it.'

When coupled with the noise pollution and visual degradation that many residents will be subjected to, it is clear that wind farm turbine setbacks should be increased to a minimum of 3,000 feet from any residence.'
[Bolton R. Evaluation of Environmental Shadow Flicker Analysis for "Dutch Hill Wind Power Project". Environmental Compliance Alliance, New York, USA, 30 January 2007]

69 This Section of the Review, **Acoustics**, provides evidence that the noise radiation from wind turbines is made up of a number of sound characters, which include low frequency noise (0Hz – 200Hz), infrasound (0Hz – 20Hz), vibration, rhythmic pulsation, and tonal qualities. Moreover, the noise combines with visual phenomena, such as strobe effects and shadow flicker, which can act synergistically with the acoustic qualities in the effects on people nearby. A prolonged dose at an appropriate level of any of these characters individually can evoke serious physiological changes in the human body, with health consequences.

Wind turbines emit a cocktail of acoustic characters and are delivered with a rhythmic, pulsating character, all of which can combine to create serious health responses from people if the wind turbines are constructed too close to their dwellings.

The ETSU-R-97 guidelines endorsed by the Dti do not protect families from the sleep deprivation and the consequent health effects where wind turbines are built too close to their homes.

Peter Hadden

Section 5.0 HEALTH EFFECTS

- 1 Levels of sound, both audible and inaudible (including that in the low frequency range) can have an adverse effect on health, not only psychologically, but also physiologically, with medical consequences. As previously discussed, wind turbines emit noise radiation, both audible and inaudible (including that in the low frequency range). The industry has struggled to accurately predict and control wind turbine noise and its impact on people in nearby dwellings, with inconsistent results. When installed near homes, the noise is not merely a persistent, unremitting nuisance. Whether in the UK, the US, Canada, the Netherlands, Australia, or elsewhere, those living near wind turbines share similar health and medical complaints.
- 2 Measuring the audibility of noise does not take into consideration that the human body also receives sound characters without the involvement of the auditory system.
- 3 Merely focusing on audible sound ignores the harmful impacts on human body organs of low frequency noise, vibration, and the whole combination of characters – e.g., pulsations – that act in combination to exacerbate the impact on the body’s organs.
- 4 Acousticians measuring noise near wind turbines do not take into account the physiologic/medical aspects of the effects of noise, as this is not their area of expertise; only those with backgrounds in medicine, the human biologic sciences, and epidemiology can properly study the effects and responses of the human body to wind turbine noise.
- 5 Moreover, measuring the audibility of a sound, its loudness, and its characteristics does not account for the dose received. Dosimetry is an important part of the equation when considering the effects of noise on human health. Although one may acclimatise to certain noises, wind turbine noise, with its pulsating nature, varying harmonics and low frequency components, does not have a time-limit factor, and continues day after day and year after year, unlike noise at work, e.g., which has a time-limit factor. Because the impact on body organs builds over a long period of time, wind turbine noise is difficult to replicate in laboratory experiments. Moreover, it would be unethical to subject people to extended exposure in the laboratory setting.
- 6 According to ‘Occupational and Community Noise’, World Health Organisation Fact Sheet No 258 (February 2001, drawn from the WHO *Guidelines for Community Noise 1999*):

‘The noise problems of the past are incomparable with those plaguing modern society ... the thumps and whines of industry provide a noisy background to our lives. But such noise can be not only annoying but also damaging to the health, and is increasing with economic development.

Health Impact. *The recognition of the noise as a serious health hazard as opposed to a nuisance is a recent development and the health effects of the hazardous noise exposure are now considered to be an increasingly important public health problem.*

- *Prolonged or excessive exposure to noise whether in the community or at work, can cause permanent medical conditions, such as hypertension ... (ref WHO Guidelines p XII).*
- *Noise can adversely affect performance, for example in reading, attentiveness, problem solving and memory. Deficits in performance can lead to accidents (ref WHO Guidelines p XII).*
- *A link between community noise and mental health problems is suggested by the demand for tranquillizers and sleeping pills ...'*

7 The WHO fact sheet continues:

Noise may 'interfere with communication, disturb sleep, cause cardiovascular and psycho-physiological effects, reduce performance, and provoke annoyance responses and changes in social behaviour ... Many countries have regulations on community noise from rail, road, construction and industrial plants based on emission standards, but few have any regulations on neighbourhood community noise, probably owing to difficulties with its definition, measurement and control. This and the insufficient knowledge of the effects of noise on people handicap attempts to prevent and control the problem.'

Environment	Critical Health Effect	Sound Level dB(A)*	Time hours
Outdoor living areas	Annoyance	50 – 55	16
Indoor dwellings	Speech intelligibility	35	16
Bedrooms	Sleep disturbance	30	8
School classroom	Disturbance of communication	35	During class

Source: Who Fact Sheet No 258, Occupational and Community Noise, February 2001.

The WHO *Guidelines for Community Noise 1999* state that:

“The potential health effects of community noise include hearing impairment; startle and defense reactions; aural pain; ear discomfort; speech interference; sleep disturbance; cardiovascular effects; performance reduction; and annoyance responses. These health effects, in turn, can lead to social handicap; reduced productivity; decreased performance in learning; absenteeism in the workplace and school; increased drug use; and accidents. In addition to health effects of community noise, other impacts are important such as loss of property value.”

- 8 Indeed, the human body does emanate measurable ‘sound’, which can be detected by various testing equipment, as is used for excluding the presence of or for diagnosing disease. For example, in ‘EEG measurement’, G Blundell notes that

The brain operates	Normal activity	13 – 30 Hz
	Relaxed	8 – 13 Hz
	Drowsiness	4 – 7 Hz
	Deep sleep	0.5 – 4 Hz

[See also Hedge, A. ‘Whole body vibration’, Cornell University, April 2002; SafetyLine Institute, Government of Western Australia, ‘Whole body vibration effects on health’, 1998]

- 9 In the paper, “Human Body Vibration Exposure and its Measurement”, G. Rasmussen looked at body vibration exposure at frequencies of 1 Hz – 20Hz. This chart details some of the findings:

Symptoms	Frequency
General feeling of discomfort	4Hz – 9Hz
Head symptoms	13Hz – 20Hz
Influence on speech	13 Hz – 20 Hz
Lump in throat	12 Hz – 16Hz
Chest pains	5Hz – 7Hz
Abdominal pains	4Hz – 10Hz
Urge to urinate	10Hz – 18Hz
Influence on breathing movements	4Hz – 8Hz

10 Rasmussen's 'mechanical man' illustrates these distributions:

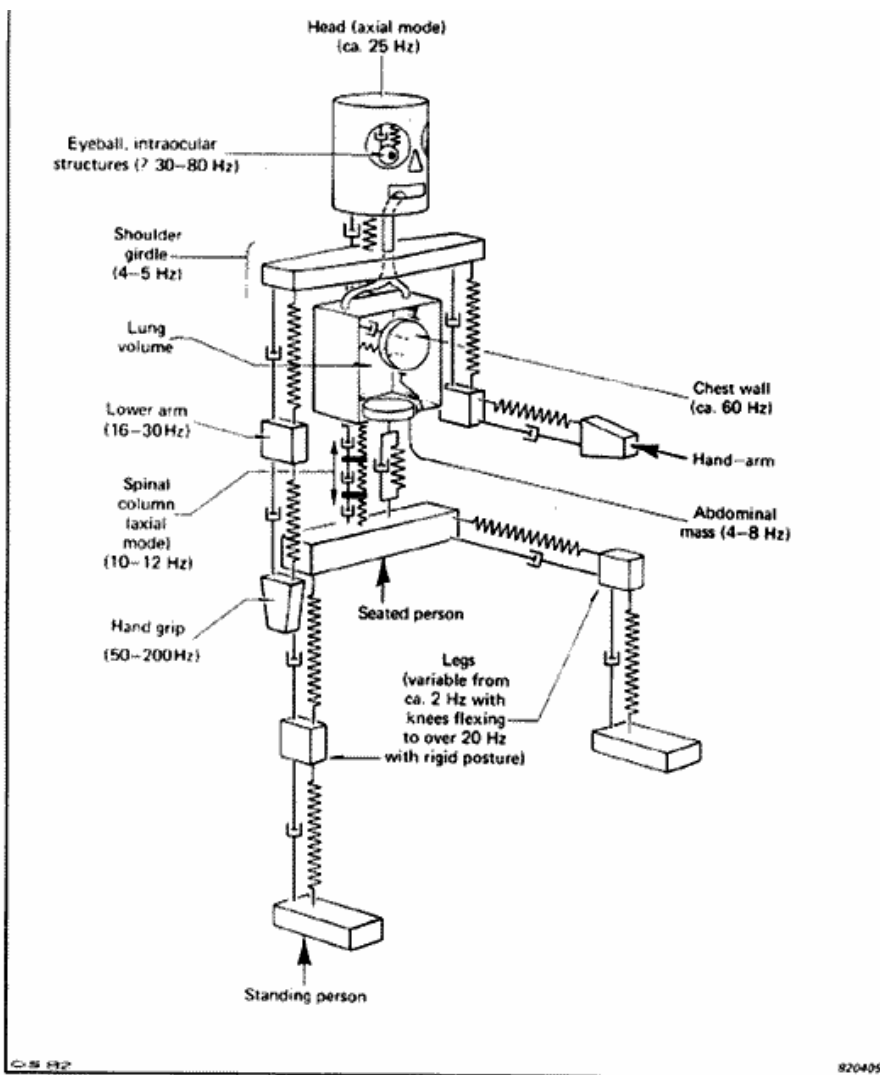

Fig. 1. Simplified mechanical system representing the human body standing on a vertically vibrating platform

Note that the head will vibrate at about 25 Hz and the chest wall at 60 Hz.

“Also, in the region 60 to 90 Hz disturbances are felt which suggest eyeball resonances, and a resonance effect in the lower jaw-skull system has been found between 100 and 200Hz.”

11 In “Community Noise Rating” [2d ed, Applied Science Publishers, 1982], the author, Theodore Shultz, wrote that the International Standards Organisation (ISO) had recently (1982) adopted a “Guide for the Evaluation of Human Exposure to Whole-Body Vibration”.

In evaluating low frequency noise and vibration, he noted that there are:

*“... four physical factors of primary importance in determining the human response to vibration: the **intensity**, the **frequency**, the **duration**, (exposure time) and the **direction** of the vibration.”*

- 12 Shultz gives limits for longitudinal (2-axis) and for transverse (x-and y-axis) vibration respectively. Each curve, or boundary, represents a limit beyond which exposure to vibration carries a significant risk of fatigue or impaired working efficiency. Shultz comments:

“The ‘exposure limit’ boundaries are similar in general form to those for fatigue: but they lie 6 dB higher and the boundaries for reduced comfort have a similar form but lie 10dB lower than the fatigue boundaries.”

*“The Standard mentions in a note that the criteria of acceptability in residential contexts, particularly at night, may lie near the threshold of detectability; for frequency bands of greatest sensitivity (4 – 8Hz for longitudinal, and 1 – 2 Hz for transverse vibration), this lies in the vicinity of **0.01m/s**, (though it varies greatly in individual circumstances).”*

Merely as a rough guide, the longitudinal acceleration limits for fatigue indicates that for 0.20 rms between 10Hz – 20Hz, the limits of exposure should not exceed 24hrs – 30hrs. For transverse exposure, the limit is only 10hrs. [Authors’ note: See also Section 4.18 or this Review]

- 13 In his coursework description of “Whole Body Vibration”, Prof Alan Hedge of Cornell University writes:

“Vibrations in the frequency range of 0.5Hz to 80Hz have significant effects on the human body.

Individual body members and organs have their own resonant frequencies and do not vibrate as a single mass, with its own natural frequency. This causes amplification or attenuation of input vibrations by certain parts of the body due to their own resonant frequencies.

The most effective resonant frequencies of vertical vibration lie between 4Hz and 8Hz.

Vibrations between 2.5 and 5Hz generate strong resonance in the vertebra of the neck and lumber region with amplification of up to 240%.

Vibrations between 4 and 6Hz set up resonances in the trunk with amplification of up to 200%.

Vibrations between 20 and 30Hz set up the strongest resonance between the head and shoulders with amplification of up to 350%.

Whole body vibration may create chronic stresses and sometimes even permanent damage to the affected organs or body parts.” [Hedge A. Whole body vibration. DEA350, April 2002, c January 2006]

- 14 The SafetyLine Institute (Government of Western Australia) notes in its documentation and coursework:

“Prolonged exposure to whole body vibration at frequencies below 20Hz results in hyperventilation, increased heart rate, oxygen intake, pulmonary ventilation and respiratory rate.

Digestive system disease often observed in persons exposed to whole body vibration over a long period of time. Associated with the resonance movement of the stomach at frequencies between 4 and 5 Hz.

Spinal column disease and complaints, perhaps the most common disease associated with long term exposure to whole body vibration, where the back is especially sensitive to the 4 – 12Hz range.”

- 15 One of the most important parts of the body with respect to vibration and shock appears to be the abdomen with the resonance occurring in the 4 – 8 Hz range. The other main resonant effect is found in the head and neck region, with a range of 20 – 30 Hz. Eyeball resonance is similar, with vibration in the range of 25 – 90 Hz. *‘The skull itself has a fundamental mode of vibration in the region of 300 – 400 Hz.’* [SafetyLine Institute of WorkSafe Western Australia, Department of Consumer and Employment Protection, Government of Western Australia. ‘Identification of whole-body vibration: Effects on Health’, SLI 1998]
- 16 Another study concurring with these results looked at human body vibration induced by low frequency noise in the range of 20 – 50 Hz:

“The level and rate of increase with frequency of the vibration turned out to be higher on the chest than on the abdomen.” [Takahashi Y; Yonekawa Y; Kanada K; Maeda S. A pilot study on the human body vibrations induced by low frequency noise. *Industrial health* 1999 Jan; 37(1): 28-35]

- 17 Berglund, Hassmen, and Job, in “Sources and effects of low frequency noise”, [Berglund B, Hassmen P, Job RF. *JASA Journal of the acoustical society of America* 1996 May; 99(5): 2985 – 3002] made these observations:

“The setting of the arbitrary lower limit of human hearing determines the lower limit of low frequency noise and the upper bound of infrasound. Such a setting is not a matter of absolutes. The threshold of hearing for tones and frequency bands depends on the loudness as well as the frequency and duration. In this sense, logically, human hearing capacity extends well below the 20 Hz range if one considers a signal that is sufficiently loud. Thus the threshold of absolute hearing extends well into the nominal infrasound range. It has been suggested that at very low frequencies human detection does not occur through hearing in the normal sense. Rather, detection results from nonlinearities of conduction in the middle and inner ear which generate harmonic distortion in the higher, more easily audible frequency range (von Gierke and Nixon 1976). This account does not dictate that the noise is not heard but rather that the method of hearing is indirect, as indeed is the mechanical method of all hearing (i.e. the relevant nerves are fired by changes in other biological structures in the ear, not directly by noise itself).”

“Second, regardless of the process by which a sound wave is detected, it is critical to consider waves which are detected through skeletal bones, the ear, harmonics, tactile senses or resonance in body organs. Detection raises the possibility of subjective reactions such as annoyance, and annoyance

may contribute in complex ways to other biological and psychological effects of the signal (Job 1993, Stansfield 1992.)”

“Third, determination of health and other effects of LFN must consider field data. Real occurrences of low frequency noise will often include considerable energy below 20Hz as well as energy in what is usually considered the LFN range. Thus the arbitrary setting of a cut off at 20Hz is not conducive to analysis of such data.”

“The determination of precisely what constitutes LFN is also not perfectly clear in terms of its upper limit. Sound up to 250Hz are sometimes referred to as LFN although others have set the upper limit of the range to 100Hz (e.g. Backteman et al 1983a).”

- 18 In referring to impulsive noise, Berglund et al commented:

“... impulsive noise generates greater levels of subjective reactions such as annoyance and dissatisfaction than does non-impulsive noise of the same energy level.”

The authors referred to the fact LFN travels extended distances with very little energy loss:

“... as the frequency wave is lowered, more of the energy enters the ear, the body and other objects (von Gierke & Nixon 1976). Thus LFN transmission extends into many objects allowing it to set up resonant vibration in our dwellings and our possessions as well as our chest cavities, sinuses, and throat.” [Berglund et al]

- 19 Although within the aircraft industry, in extensive research on vibroacoustic disease (VAD, i.e., LFN-induced pathology), Dr M Pereira found that:

‘... when continuous LFN is present in the home it can cause VAD. When pulsating LFN is experienced in the home it can aggravate the LFN induced pathology, either by making particular signs and symptoms more severe or by accelerating the onset of other signs and symptoms.

*‘Mainstream concepts hold that acoustical phenomena impact the human body through the auditory system. While this may be true for certain regions of the acoustical spectrum, there are other regions of the acoustical spectrum (0 – 250Hz – LFN) where acoustical phenomena impact the human body **without** the involvement of the auditory system. **So any study that tries to understand the effects of LFN, as it is perceived by the auditory system is missing the point.**’*

- 20 For those in work environments with extended exposure to large pressure amplitude and LFN (LPALF), e.g., for aircraft technicians, vibroacoustic disease is an occupational health hazard, a disease process that was studied extensively after patterns of health problems were observed.

- 21 In one study by Castelo Branco et al [Castelo Branco NA, Rodriguez E, Alves-Pereira M, Jones DR. Vibroacoustic disease: some forensic aspects. *Aviation, space, and environmental medicine* 1999 Mar; 70(3 Pt 2): A145-51], among 236

aircraft technicians, the disabilities manifested themselves after a minimum of 16 years. Disabilities included neurological (34%), psychiatric (9.7%), cardiovascular (6.8%), and osteoarticular (5.9%). Echocardiograms (EEGs) showed ‘characteristic changes in pericardial structures’, with five pericardial layers instead of three.

Among the study participants, 73% were disabled after an average of 24 years.

- 22 An important aspect of these studies is the observation that not only can noise have adverse health effects, but also that low frequency noise can adversely impact the human body. This is because, to reiterate, although people perceive sounds and noise via the auditory system:

“Acoustical phenomena impact the human body without the involvement of the auditory system” and “any study that tries to understand the effects of LFN, as it is perceived by the auditory system is missing the point”. [M Alves-Pereira]

- 23 In 2002, Moller and Lydolf [Moller H and Lydolf M. A survey of complaints of infrasound and low frequency noise. Journal of low frequency noise, vibration and active control 2002; 21(2): 53-63] reported on 198 persons who had reported complaints about noise, identified as infrasound and low frequency noise:

“Their verbal reports often described the sound as deep and humming or rumbling, as if coming from the distant idling engine of a truck or pump. Nearly all respondents reported a sensory perception of sound. In general they reported that they perceived the sound with their ears, but many mention also the perception of vibration, either in the body or external objects.”

The authors continue:

“The sound disturbs and irritates during most activities, and many consider its mere presence as a torment to them. Many of the respondents reported secondary effects, such as insomnia, headache and palpitation. Typically, measurements have shown that existing limits (and hearing thresholds) are not exceeded.”

Moller and Lydolf suggest that there is ample evidence to pursue this research issue further, including the frequencies and levels involved.

- 24 Research published in 2003 on low frequency and broadband noises and annoyance [Pawlaczyk-Luszczynska M, Dudarewicz A, Waszkowska M, Sliwinska-Kowalska M. Assessment of annoyance from low frequency and broadband noises. International journal of occupational medicine and environmental health 2003; 16(4): 337-43] shows that:

“LFN was rated as significantly more annoying than BBN at the comparable A-weighted sound pressure levels. The annoyance assessment of either noise did not depend on age, length of employment or the level of exposure to noise at a current workplace. LFN presents a high risk of influencing human well-being ...”

Indeed, additional studies, most in controlled environments and laboratories, have confirmed their findings.

- 25 In a 2004 study conducted at the Nofer Institute of Occupational Medicine in Lodz, Poland, the authors wrote [Pawlaczyk-Luszczynska M, Dudarewicz A, Waszkowska M, Szymczak W, Kamedula M, Sliwinska-Kowalska M. The effect of low frequency noise on human mental performance [article in Polish]. *Medycyna pracy* 2004; 55(1):63-74]:

‘There is a growing body of data showing that low frequency noise (LFN) defined as broad band noise with dominant content for low frequencies (10 – 250 Hz) differs in its nature from other noises at comparable levels. The aim of this study was to assess the influence of LFN on human mental performance. Subjects were 193 male paid volunteers ... LFN at 50 dB(A) could be perceived as annoying and adversely affecting mental performance (concentration and visual perception) ...

- 26 In another study by this group of 96 men and women, [Pawlaczyk-Luszczynska M, Dudarewicz A, Waszkowska M, Szymczak W, Sliwinska-Kowalska M. The impact of low frequency noise on human mental performance. *International journal of occupational medicine and environmental health* 2005; 18(2): 185 - 198], the authors note that:

“Low frequency noise differs in its nature from other environmental noise at comparable levels, which are not dominated by low frequency components.” [See also Berglund et al, Sources and effects of low frequency noise, *JASA* 1996]

Pawlaczyk-Luszczynska et al continue:

“Recent investigations show that low frequency noise at relatively low A-weighted sound pressure levels (about 40 – 45 dB) can be perceived as annoying and adversely affecting the performance, particularly when executing more demanding tasks. Moreover, persons classified as sensitive to low frequency noise may be at a higher risk.”

The results of this study *“supports a hypothesis that LFN at levels normally occurring in the control rooms (at about 50 dB(A)) might adversely influence the human mental performance and lead to work impairment.”*

These authors also note that *“previous studies on the effects of community LFN (in dwelling rooms) showed that subjects sensitive to this type of noise were not necessarily sensitive to noise in general as measure by noise sensitivity scales ... Sensitivity to this special type of noise [LFN] was somewhat different from sensitivity in general.”*

“LFN at relatively low A-weighted SPL (about 40 dB) could be perceived as annoying and adversely affecting the performance, particularly when mentally demanding tasks were executed ...” [see also Persson Waye et al, Low frequency noise pollution interferes with work performance. *Noise and health* 2001 Oct-Dec; 4(13): 33 – 49]

The subjects “*reported a higher degree of annoyance and impaired working capacity during exposure to LFN ... LFN adversely affected performance in two tasks sensitive to reduced attention in a proof-reading task.*” [see also Bengtsson et al. Evaluation of effects due to low frequency noise in a low demanding work situation. Journal of sound and vibration 2004; 278(1/2): 83 – 99]

The authors conclude that “*the adverse effect of LFN at 50 dB(A) (compared to reference noise without dominant content of low frequencies) on performance was found in tasks demanding perceptiveness and concentration ... Moreover, during exposure to LFN, differences in performance between higher and lower sensitive-to-noise subjects were observed in tasks requiring visual differentiation and selective or continuous attention; the persons categorized as high-sensitive to LFN achieved worse results than low-sensitive ones.*” [Pawlaczyk-Luszczynska M, Dudarewicz A, et al, 2005]

- 27 Subsequent research reinforces the WHO *Guidelines for Community Noise 1999*. Pedersen and Persson Waye [Pedersen E, Persson Waye K. Perception and annoyance due to wind turbine noise – a dose-response relationship. JASA Journal of the acoustical society of America 2004 Dec; 116(4): 3460-70] studied the dose-response relationship of perception and annoyance caused by wind turbines. Their results conclude that:

“a significant dose-response relationship between calculated A-weighted SPL from wind turbines and noise annoyances was found. The prevalence of noise annoyance was higher than what was expected from the calculated dose.”

The authors recommend further studies, to include the effect of visual impact.

In their paper, Pedersen and Persson Waye identify a factor that supports the WHO Guidelines in its discussion of sleep disturbance:

This “wind turbine study was performed in a rural environment, where a low background level allows perception of noise sources even if the A-weighted SPL are low.”

“Wind turbine noise was perceived by about 85% of the respondents even when the calculated A-weighted SPL were as low as 35.0 – 37.5 dB. This could be due to the presence of amplitude modulation in the noise, making it easy to detect and difficult to mask by ambient noise. This is also confirmed by the fact that the aerodynamic sounds were perceived at a longer distance than machinery noise.”

Although Pedersen and Persson Waye found that “*visual and/or aesthetic interference influenced noise annoyance*”, they also found that “*the influence of noise exposure was still a significant factor for noise annoyance.*”

As the authors note:

“The high prevalence of noise annoyance could also be due to the intrusive characteristics of the aerodynamic sound ... The verbal descriptors of sound characteristics related to the aerodynamic sounds of swishing, whistling, pulsating/throbbing, and resounding were – in agreement with this hypothesis – also reported to be most annoying.”

The extent of the impact of noise is pervasive:

“Most respondents who were annoyed by wind turbine noise stated that they were annoyed often, i.e., every day or almost every day. The high occurrence of noise annoyance indicates that the noise intrudes on people’s daily life.”

Although their data was not extensive enough to draw conclusions on wind turbine noise and sleep disturbance, based on their observations they recommend that:

“... the probability of sleep disturbances due to wind turbine noise can not be neglected at this stage.” [Pedersen and Persson Waye, 2004]

- 28 There are numerous studies addressing the problems of noise causing sleep disturbance. The noise may be an annoyance but may also trigger physiologic changes that are signs of physiologic (bodily) stress.
- 29 In an article published in 2004, Griefahn and Spreng [Griefahn B, Spreng M. Disturbed sleep patterns and limitation of noise. *Noise and health* 2004 Jan-Mar; 6(22): 27-33] note that because of:

“... the indisputable restorative function of sleep, noise-induced sleep disturbances are regarded as the most deleterious effects of noise. They comprise alterations during bedtimes such as awakenings, sleep stage changes, body movements and after-effects such as subjectively felt decrease of sleep quality, impairment of mood and performance. The extents of these reactions depend on the information content of noise, on its acoustical parameters, and are modified by individual influences and by situational conditions.”

In context with the described nature of wind turbine noise, Griefahn and Spreng note that intermittent noise *“is particularly disturbing and needs to be reduced.”*

- 30 When the human body responds to stress, there are biological functions activated:

These functions *“serve an important role in the organism’s adaptation to the environment by protecting and restoring the body but may, under certain conditions, also have health damaging consequences.”* [Lundberg U. Coping with stress: neuroendocrine reactions and implications for health. *Noise and health* 1999; 1(4): 67-74] Lundberg writes that *“knowledge about these psychobiological pathways is of considerable importance for the possibilities to prevent and treat environmentally induced ill health.”*

- 31 Further research by Ising et al [Ising H, Babisch W, Kruppa B. Noise-induced endocrine effects and cardiovascular risk. *Noise and health* 1999; 1(4): 37-48] reiterates that:

“Noise has the potential to cause stress reactions. Chronic noise-induced stress accelerates the ageing of the myocardium and thus increases the risk of myocardial infarction.”

The authors note that:

“The involved pathomechanisms include acute increase of catecholamines or cortisol under acute noise exposure and an interaction between endocrine reactions and intracellular Ca/Mg shifts.”

Furthermore:

“Recent epidemiological studies support the importance of noise as a risk factor in circulatory and heart diseases, especially in myocardial infarction.”

- 32 As Spreng notes [Spreng M. Possible health effects of noise induced cortisol increase. *Noise and health* 2000; 2(7): 59-64]:

“The auditory system is permanently open – even during sleep ... Thus noise causes the release of different stress hormones (e.g., corticotrophin releasing hormone: CRH; adrenocorticotrophic hormone: ACTH) especially in sleeping persons during vagotropic night/early morning phase. These effects occur below the waking threshold of noise and are mainly without mental control.”

For example, *“Increased cortisol levels have been found in humans when exposed to aircraft noise or road traffic noise during sleep.”*

As a consequence, this imbalance has possible adverse health outcomes. *“The effects of longer-lasting activation of the HPA-axis, especially long-term increase of cortisol, are manifold”*, and include cardiovascular diseases.

Spreng also found that:

“Longer lasting activation of the HPA-axis, especially abnormally increased or periodically elevated levels of cortisol ... may lead to disturbed hormonal balance and even severe disease.” [Spreng M. Central nervous system activation by noise. *Noise and health* 2000; 2(7): 49-58]

- 33 Wust et al, in their research published in 2000 [Wust S, Wolf J, Hellhammer DH, Federenko I, Schommer N, Kirschbaum C. The cortisol awakening response – normal values and confounds. *Noise and health* 2000; 2(7): 79-88], state that:

“When measured with strict reference to the time of awakening the assessment of this endocrine response is able to uncover subtle changes in hypothalamus-pituitary-adrenal (HPA) axis activity, which are, for instance, related to persisting pain, burnout and chronic stress.”

The HPA axis changes may serve as an indicator *“in subjects exposed to prolonged environmental noise.”* The authors looked at four separate studies with a total of 509 subjects to *“provide reliable information on normal values for the free cortisol response to awakening. Corresponding with earlier findings, a mean cortisol increase of about 50% within the first 30 minutes after awakening was observed.”*

This reinforces the determination of cortisol levels as a useful tool in identifying physiologic changes that may have clinical significance. *“The cortisol awakening response can be assessed under a wide variety of clinical and field settings, since it is non-invasive, inexpensive and easy-to-employ.”*

- 34 In their review on the acute and chronic endocrine effects of noise [Ising H, Braun C. Acute and chronic endocrine effects of noise: review of the research conducted at the Institute for Water, Soil and Air Hygiene (Berlin, Germany). *Noise and health* 2000; 2(7): 7 – 24], Ising and Braun cover research results from the early 1980s, during which time:

“... mechanisms of acute noise-induced stress reactions as well as long-term increase of stress hormones in animals and persons under chronic noise exposure were studied.”

They note that:

“... habituated noise caused a chronic increase of noradrenaline from the sympathetic synapses under longterm noise exposure at work. Environmental noise exposure ($Leq \geq 60$ dB(A)) caused catecholamine increase if activities such as conversation, concentration, recreation etc. were disturbed through noise.”

However, for a sleeping person, *“... traffic noise with only $Leq \geq 30$ dB(A) and $L_{max} \geq 55$ dB(A) caused significant acute increase of cortisol, which developed into chronic increase if the noise exposure was repeated consistently.”*

- 35 In 2002, Babisch [Babisch W. The noise/stress concept, risk assessment and research needs. *Noise and health* 2002; 4(16): 1-11] states that:

“In principle, the noise/stress hypothesis is well-understood: Noise activates the pituitary-adrenal-cortisol axis and the sympathetic-adrenal-medullary axis. Changes in stress hormones including epinephrine, norepinephrine and cortisol are frequently found in acute and chronic noise experiments.”

“Cardiovascular disorders are especially in focus for epidemiological studies on adverse noise effects ... The relative importance and significance of health outcomes to be assessed in epidemiological noise studies follow a hierarchical order, i.e., changes in physiological stress indicators, increase

in biological risk factors, increase of the prevalence or incidence of diseases, premature death.”

“Magnitude of effect, dose-response relationship, biological plausibility and consistency of findings among studies are issues of epidemiological reasoning.”

Babisch identifies the need for further research:

“The cardiovascular risk is a key-outcome in non-auditory noise effects’ research because of the high prevalence of related diseases in our communities. Specific studies regarding critical groups, different noise-sources, day/evening/night comparisons, coping styles and other effect-modifying factors, and the role of annoyance as a mediator of effect are issues for future research in this field.”

- 36 Babisch emphasises these points [Babisch W. Stress hormones in the research on cardiovascular effects of noise. *Noise and health* 2003 Jan-Mar; 5(18): 1-11]:

“Since endocrine changes manifesting in physiological disorders come first in the chain of cause-effect for perceived noise stress, noise effects in stress hormones may therefore be detected in populations after relatively short periods of noise exposure.”

Therefore, *“Stress hormones can be used in noise studies to study mechanisms of physiological reactions to noise and to identify vulnerable groups.”*

- 37 Maschke and Hecht underscore the association of changes in stress hormones and sleep disturbances [Maschke C, Hecht K. Stress hormones and sleep-disturbances – electrophysiological and hormonal aspects. *Noise and health* 2004 Jan-Mar; 6(22): 49-54]:

“Frequent or long awakening reactions endanger therefore the necessary recovery in sleep and, in the long run, health. Findings derived from arousal and stress hormone research make possible a new access to the noise induced nightly health risk.”

The author adds that, *“Frequent occurrences of arousal triggered by nocturnal noise”* disturbs the circadian rhythm. *“Additionally, the deep sleep phases in the first part of the night are normally associated with a minimum of cortisol and a maximum of growth hormone concentrations.”*

The physical well-being and *“psychic recovery of the sleeper”* rely on the circadian rhythms *“of sleep and neuroendocrine regulations.”*

“Noise exposure during sleep which causes frequent arousal leads to decreased performances capacity, drowsiness and tiredness during the day. Long-term disturbances of the described circadian rhythms have a deteriorating effect on health, even when noise induced awakenings are avoided.” [Maschke C and Hecht K, 2004]

- 38 Spreng [Spreng M. Noise induced nocturnal cortisol secretion and tolerable overhead flights. *Noise and health* 2004 Jan-Mar; 6(22): 35-47] notes that:

“repeated noise events (e.g., overflights during night times) may lead to accumulation of the cortisol level in blood.”

“This fact and the unusual large permeability of cortisol through the cell membranes opens a wide field of connections between stress-dependent cortisol production and the disturbance of a large number of other endocrine processes, especially as a result of long-term stress activation by environmental influences such as environmental noise.”

- 39 Initial research into low frequency noise in a workplace [Bengtsson J, Persson Waye K, Kjellberg A. Evaluations of effects due to low-frequency noise in a low demanding work situation. *J Sound Vibration* 2004; 278: 83-99] was tested on subjects using two ventilation noises at 45 dB(A), one with low-frequency noise character. Most of the tasks required of the subjects were routine and undemanding.

“The major finding was that low-frequency noise negatively influenced performance on two tasks sensitive to reduced attention and on a proof-reading task, while performance of tasks aimed at evaluating motivation were not significantly affected. The negative effects on performance were not reflected by the subjective reports.”

- 40 Further research has shown that noise with a low-frequency component also has an effect on cortisol levels. In a work environment experiment with “*exposure to ventilation noise, with dominant low frequencies (low-frequency noise) or a flat frequency spectrum (reference noise)*”, with both noises at 40 dB(A): [Waye KP, Bengtsson J, Rylander R, Hucklebridge F, Evans P, Clow A. Low frequency noise enhances cortisol among noise sensitive subjects during work performance. *Life sciences* 2002 Jan 4; 70(7): 745-58]

“The normal circadian decline in cortisol concentration was however significantly attenuated in subjects high-sensitive to noise in general, when they were exposed to the low frequency noise. This noise was rated as more annoying and more disruptive to working capacity than the reference noise. The study showed physiological evidence of increased stress related to noise sensitivity and noise exposure during work.”

This study demonstrates the “*effect of moderate levels of noise on neuroendocrine activity.*”

The authors conclude that “*The impact of long-term exposure to moderate noise levels, and particularly low frequency noise, in the workplace deserves further investigation.*”

- 41 Noise and noise with a low frequency component influence cortisol levels during sleep as well. [Waye KP, Clow A, Edwards S, Hucklebridge F, Rylander R. Effects of nighttime low frequency noise on the cortisol response to awakening and subjective sleep quality. *Life sciences* 2003 Jan 10; 72(8): 863 – 875]

- 42 Waye et al studied traffic noise or low frequency noise (LFN) and night-time effects on the cortisol awakening response and subjective sleep quality:

“A significant interaction between night time exposure and time was found for the cortisol response upon awakening. The awakening cortisol response following exposure to LFN was attenuated at 30 minutes after awakening. Subjects took longer to fall asleep during exposure to LFN.”

“This study thus showed that night time exposure to LFN may affect the cortisol response upon wake up and that lower cortisol levels after awakening were associated with subjective reports of lower sleep quality and mood.”

- 43 The WHO *Guidelines for Community Noise 1999* address sleep disturbance caused by noise:

‘Measurable effects of noise on sleep begin at LAeq levels of about 30 dB. However, the more intense the background noise, the more disturbing is its effect on sleep. Sensitive groups mainly include the elderly, shift workers, people with physical or mental disorders and other individuals who have difficulty sleeping.

Sleep disturbance from intermittent noise events increases with the maximum noise level. Even if the total equivalent noise level is fairly low, a small number of noise events with a high maximum sound pressure level will affect sleep. Therefore, to avoid sleep disturbance, guidelines for community noise should be expressed in terms of the equivalent sound level of the noise, as well as in terms of maximum noise levels and the number of noise events. It should be noted that low-frequency noise, for example, from ventilation systems, can disturb rest and sleep even at low sound pressure levels.

*When noise is continuous, the equivalent sound pressure level should not exceed 30 dB(A) indoors, if negative effects on sleep are to be avoided. For noise with a large proportion of low-frequency sound a still lower guideline value is recommended. When the background noise is low, noise exceeding 45 dB LAmax should be limited, if possible, and for sensitive persons an even lower limit is preferred. Noise mitigation targeted to the first part of the night is believed to be an effective means for helping people fall asleep. It should be noted that the adverse effect of noise partly depends on the nature of the source. A special solution is for newborns in incubators, for which the noise can cause sleep disturbance and other health effects.’ (WHO *Guidelines for Community Noise*, p xiii, 1999)*

- 44 Physicians, particularly general practitioners who are community-based, are often the first to detect patterns of symptoms described by their patients. Thus was the situation for Dr Amanda Harry, a physician in Cornwall, who in 2003 noted that patients began complaining of poor sleep, headaches, stress, and anxiety. [Harry A. *Wind Turbines, Noise and Health*. In process for publication, 2007] For example, further discussion with one couple revealed that their health problems coincided with the commissioning of wind turbines, approximately 400 meters from their home. Their symptoms were relieved when they were away from their home, and from the wind turbines. Their symptoms occurred

when the wind blew in certain directions: the noise was sometimes so disrupting that they would go to a nearby bed and breakfast, just far enough away to sleep undisturbed.

- 45 As a result of her initial clinical observations, Dr Harry investigated further, finding that physicians elsewhere had noted – as had those living near wind turbines have reported – a similar constellation of symptoms. Dr Harry’s research included contact and interviews with respondents from a number of sites near wind turbines in the UK – Wales, Cornwall, and the north of England; her international contacts have included among them, France, Germany, Portugal, the Netherlands, and the USA.

Based on her research, Dr Harry concludes that *‘further independent research is warranted’*, although she also notes reluctance for those affected to participate:

‘There is much concern within communities that if one is seen to complain about the noise that if they decide to move away their properties will be difficult to sell and possibly devalued as a result. Therefore they feel that they are in a “Catch 22” situation.’

- 46 As a concerned and inquisitive health professional, Dr Harry initiated her own independent pilot study, as she noted a dearth of research on the health effects of wind turbine noise.

The three key areas surveyed by Dr Harry included:

1. *Has your health in any way been affected since the erection of these turbines?*
-- 81% of the 42 respondents reported that their health had been affected.
2. *As a result, have you gone to see your doctor?*
-- 76% of the respondents felt that the effects had been severe enough to initiate a visit to a physician.
3. *Do you feel that your quality of life has in any way been altered since living near the wind turbines?*
-- 73% of these respondents reported that their quality of life had been adversely impacted.

The following charts summarise the responses by those included in this pilot phase.

Note that 80% of respondents felt that the presence of wind turbines had precipitated at least one symptom that impelled them to visit their physicians.

“Do you feel that since living near a wind turbine you have experienced an excess of any of the following symptoms?”

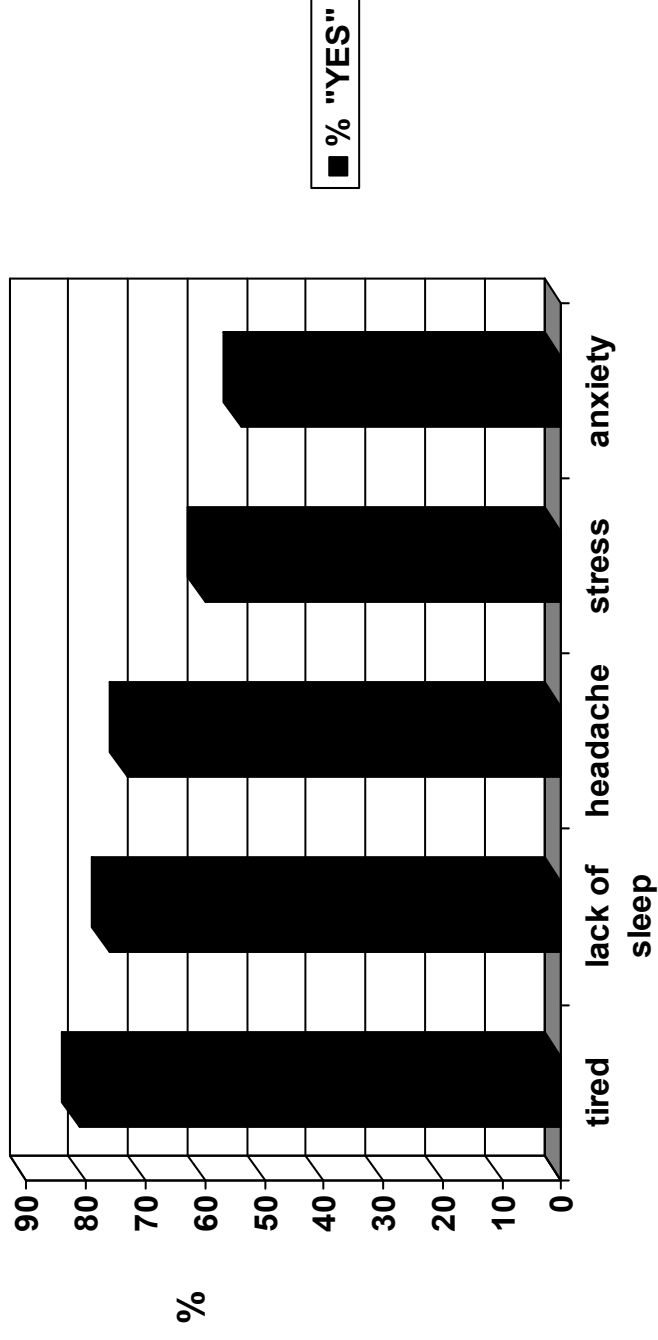

Top 5 Self-reported Health Symptoms

2006 UK Wind Turbine Survey (n = 37)

2006 UK Wind Turbine Health Survey: 3 Key Questions

1. *Has your health in any way been affected since the erection of these turbines?*
2. *As a result, have you gone to see your doctor?*
3. *Do you feel that your Quality of Life has in any way been altered since living near the wind turbines?*

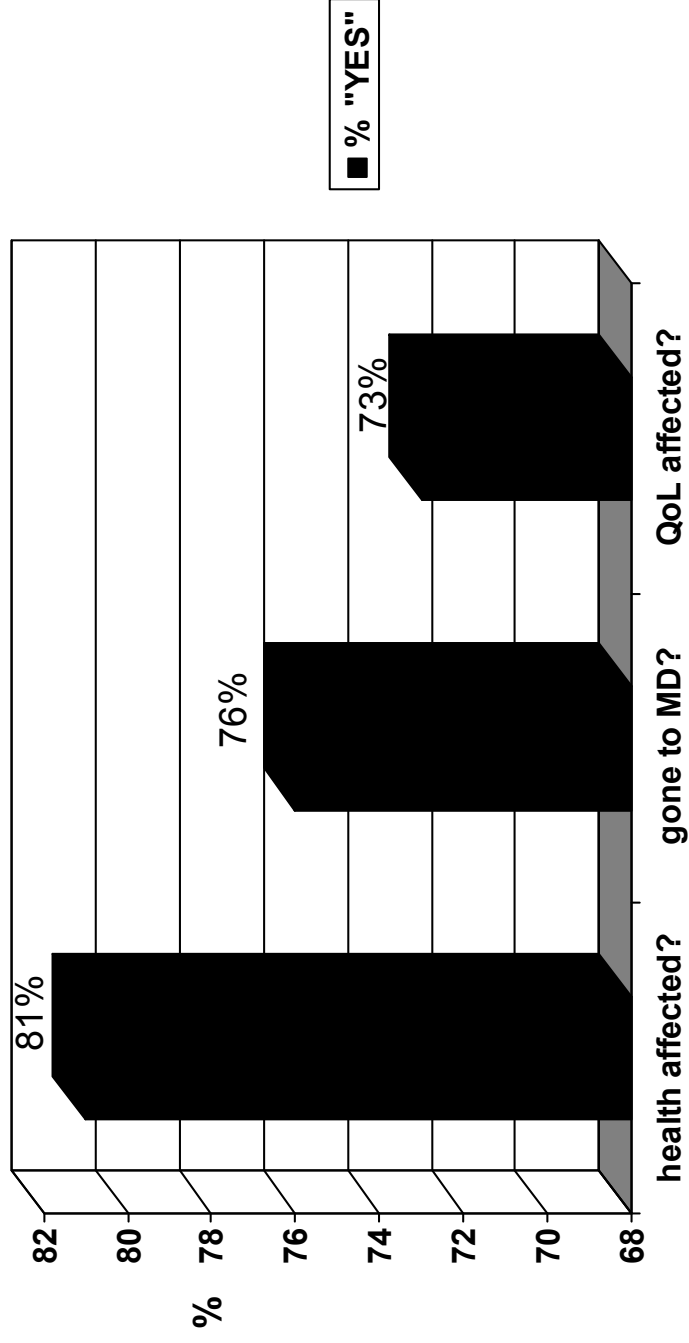

Top 5 Self-reported Health Symptoms

2006 Devon Wind Turbine Survey (n = 42)

47 Dr Harry's inquiries led her to conclude:

'There are people living near turbines who are genuinely suffering from health effects from the noise produced by wind turbines. These neighbours of turbines clearly state that at times the noise from turbines is unbearable. The developers are usually heard to say that noise is not a problem. Clearly this cannot be the case.'

'Some of these acoustic experts have made statements categorically saying that the low frequency noise from turbines does not have an effect on health. I feel that these comments are made outside their area of expertise and should be ignored until proper medical, epidemiological studies are carried out by independent medical researchers.'

48 **As a result of her observations and investigation, Dr Harry concluded that wind turbines should be sited not less than 1.5 miles (2.4 km) from the nearest home or residential facility.**

49 The impact of wind turbines on health has commanded the attention of physicians elsewhere. On the basis of patient contacts and research into existing medical evidence, Nina Pierpont, MD, PhD, a physician with a practice in New York State [USA], has suggested that the emerging pattern of complaints by those living near wind turbines is not coincidental. Dr Pierpont supports renewable energy but says that the place for wind energy *'is not near people's homes or near schools, hospitals, or other locations where people have to sleep or learn'*.

50 As Pierpont notes, wind farms are *'large industrial installations'* that produce *'large scale, industrial noise'*. [Pierpont N. Wind Turbine Syndrome: testimony before the New York State Legislature Energy Committee, March 7, 2006] Pierpont summarises the constellation of symptoms as *'Wind Turbine Syndrome'*; these symptoms include:

1. Sleep problems. Noise or physical sensations of pulsation or pressure make it difficult to go to sleep and cause frequent awakening;
2. Headaches. Headaches increase in frequency or severity;
3. Dizziness, unsteadiness, nausea;
4. Exhaustion, anxiety, anger, irritability, and depression;
5. Problems with concentration and learning; and,
6. Tinnitus (ringing in the ears).

'Chronic sleep disturbance is the most common symptom. Exhaustion, mood problems, and problems with concentration and learning are natural outcomes of poor sleep.'

Pierpont also notes that *'Deciding whether people have significant symptoms is not within the expertise of engineers or specialists in acoustics ...'* Moreover, *'not everyone near turbines has these symptoms ... there are differences among people in susceptibility. These differences are known as risk factors ...'*

51 Pierpont mentions several risk factors:

1. Sensitivity to low frequency vibration, which is highly variable in people, and poorly understood [lack of research].
2. Pre-existing migraine disorder – migraines are not merely severe headaches. Migraines are a *'complex neurologic phenomenon which affects the visual, hearing, and balance systems'*, and can affect motor control and consciousness. Many people who experience migraines have heightened sensitivity to noise and to motion.

People rely on the input from three sources in order to maintain balance: the eyes; the 'stretch receptors in joints and muscles'; and 'balance organs in the inner ear'. To maintain balance, two of these systems must be working in agreement. If not, *'one feels both ill and unsteady'*, as with vertigo or seasickness.

'Wind turbines impinge on this system in two ways: by the visual disturbance of the moving blades and shadows, and by noise or vibration impacting the inner ear.'

3. Age-related changes in the inner ear – *'Disturbing the inner ear disturbs mood, not because a person is a whiner or doesn't like turbines, but because of neurology.'*

Pierpont continues:

'Data from a number of studies and individual cases document that in rolling terrain, disturbing symptoms of the Wind Turbine Syndrome occur up to 1.2 miles from the closest turbine. In long Appalachian valleys, with turbines on ridge-tops, disturbing symptoms occur up to 1.5 miles away. In New Zealand, which is more mountainous, disturbing symptoms occur up to 1.9 miles away.'

52 As with other health professionals and those other professionals and organisations who have scrutinised the health effects of wind turbine noise, **Pierpont recommends a minimum setback of 1.5 miles (2.4 km) of wind turbines from people's homes, schools, hospitals, and similar institutions**, while also urging appropriate epidemiologic studies and analysis of clinical data by qualified, independent medical researchers.

53 Indeed, the medical research literature supports the clinical observations of Drs Harry and Pierpont, as well as those by researchers such as Pedersen, Persson Waye, Berglund, and van den Berg. Moreover, as already mentioned, the symptoms described by those living near wind turbines coincide with those symptoms described in the broader literature examining noise and its health effects. Those living near wind turbines complain not only of noise, but also of the character of that noise (impulsive, pulsating, periodic), as well as the impact and synergy of the 'visual noise' of wind turbines, i.e., the shadow flicker and strobe effect from the motion of the blades.

54 Earlier research in the area of headache and migraine showed that patients with tension headaches or migraine are more sensitive to light (photophobia) and

sound (phonophobia) than those who are not prone to headaches. Those who are prone to tension headache or migraine are more sensitive to light and noise even during the intervals between headache occurrences. (Those with cluster headaches are more sensitive during headache, but not during remission.) [Drummond PD. Sensitivity to light and noise in tension-type and cervicogenic headache. *Cephalalgia* 1998; 18: 303]

Drummond also states that:

‘Mechanisms that normally suppress photophobia are disrupted during the headache-free interval as well as during migraine. The persistence of phonophobia in various forms of headache implies that a similar process modifies sensitivity to sound ...’

- 55 Many who live near wind turbines complain of headaches and migraines (new onset of problem or exacerbation), e.g., as with more than 70% of Dr Harry’s respondents. (See also Section 3.0 of this paper, Overview of the Problems.) Indeed, researchers have studied phonophobia and photophobia (including flicker) and their association with headache and migraine, which may help explain some of the clinical symptoms shared by those living near wind turbines – although epidemiologic studies are clearly urged.

Moreover, researchers have also noted that learning can be affected by noise; for example, Wolach and Pratt found that:

‘Processing was prolonged when the distracter items were phonological.’
[Wolach I; Pratt H. The mode of short-term memory encoding as indicated by event-related potentials in a memory scanning task with distractions. *Clinical neurophysiology* 2001 Jan; 112(1): 186 – 197]

- 56 Between 70% – 83% of migraine patients are phonophobic during an attack, and 76% remain more sensitive between attacks. Headache patients – both tension-type and migraine – were hypersensitive to sound both with and without pain. [Vanagaite Vingen J, Pareja JA, Støren O, White LR, Stovner LJ. Phonophobia in Migraine. *Cephalalgia* 1998; 18: 243-249]

Furthermore, Vanagaite Vingen et al found that:

‘... the results of the questionnaire study refute the argument that anxiety about provoking attacks is the main cause of the increased sensitivity to sound outside attacks.’

- 57 Researchers have also studied how trigger factors acquire the capacity to precipitate headache. In one study [Martin PR. How do Trigger Factors acquire the capacity to precipitate headaches? *Behaviour Research and Therapy* 2001; 39: 545-554], participants were exposed to validated trigger factors:

‘“visual disturbance” (flicker, glare and eyestrain) induced by a very bright, stroboscopic light’:

‘The headache sufferers experienced more visual disturbance and head pain in response to the stimulus than the non-headache individuals.’

Martin concludes that *'more research is needed urgently to clarify the processes by which trigger factors acquire and lose their capacity to precipitate headaches'* – some studies recommend avoidance of triggers, while others recommend desensitisation.

- 58 In 2003, McKendrick and Badcock analysed flickering stimuli between migraine attacks. [McKendrick AM, Badcock DR. An analysis of the factors associated with visual field deficits measured with flickering stimuli in-between migraine. *Cephalalgia* 2004; 24: 389-397] In this study, the authors measured flicker perimetric performance in a broad group of migraine sufferers and found that:

'The migraine groups showed significantly lower general sensitivity across the visual field and higher incidence of localized visual field deficits relative to controls.'

(Note: The most severe migraine sufferers, those on preventative therapy, were not included in this study.)

The authors also suggest that *'there is some contribution of both migraine frequency and cumulative migraine history in determining general sensitivity to flickering stimuli across the visual field.'*

In addition, the authors found *'a weak, but statistically significant, correlation between decreased generalized sensitivity and increased migraine frequency. Abnormalities in cortical neuronal function that increase susceptibility to migraine, thereby resulting in more frequent attacks, may manifest as decreases in generalized visual sensitivity ...'* This implies *'... some cumulative effect of migraine on visual processing'*.

- 59 It is not only migraine sufferers whose attacks may be triggered or exacerbated by light or noise. One study looked at headaches triggered by negative affect or by noise, analysing physiologic responses,

'including 'headache intensity ratings, forehead electromyographic activity, heart rate, blood pressure, and temporal pulse amplitude (TPA).' (*'TPA is thought to be a measure of arterial distension caused by the passage of the pressure pulse.'*) [Martin PR, Todd J, Reece J. Effects of Noise and a Stressor on Head Pain. *Headache* 2005; 45: 1353-1364]

The authors note that physiologic changes occur during an episode of headache: *'... both stressor and visual disturbance could trigger headaches. The stressor was associated with increases in blood pressure, heart rate, and temporal pulse amplitude (TPA), while visual disturbance was associated with increases in blood pressure only.'*

One group of subjects, the Stressor group, was given highly difficult anagrams to solve, accompanied by failure feedback to create anxiety and mood change. Another group of subjects was exposed to a 'Noise Challenge', a white noise that resembled a loud and un-tuned television set. As the authors observe, those exposed to the Noise had an aversive response.

A third group, exposed to both Stressor and the Noise Challenge simultaneously, rated noise levels as higher than the group exposed only to the noise, even though the noise levels were identical.

The authors found that *'79% of subjects exposed to noise developed a headache.'*

Significantly: ***'Increased headache ratings occurred during the noise challenge relative to the control condition and continued through the recovery period even though the noise was no longer present.'*** [emphasis added]

Moreover, while 'Negative Affect' (those exposed only to the Stressor of the anagrams) was not associated with physiologic changes when compared to controls:

'The Noise Challenge led to elevated TPA [Temporal Pulse Amplitude].'

- 60 Martin, Todd, and Reece note that in a previous study, Martin and Teoh had found that visual disturbance as a trigger for headache was also associated with physiologic changes, specifically increases in blood pressure, heart rate, and TPA. [Martin PR, Teoh H-J. Effects of visual stimuli and a stressor on head pain. *Headache* 1999; 39: 705-715]

Martin, Todd, and Reece conclude that:

'... none of the physiological changes associated with headache induction were in terms of muscle tension – all were in terms of cardiovascular variables.' [emphasis added]

- 61 Martin, Reece, and Forsyth looked more closely at headaches and noise exposure and sensitivity. Headache sufferers most commonly report stress, anxiety, glare, and noise, as triggers; negative affect, visual disturbance, hunger, and noise are experimentally validated triggers. [Martin PR, Reece J, Forsyth M. Noise as a trigger for headaches: relationship between exposure and sensitivity. *Headache* 2006; 46: 962-972]

In this study, the authors consider whether those who suffer headaches should endure short exposure to triggers to desensitise themselves to the trigger (hypothetically), although this might lead to increased sensitivity (again, hypothetically).

The authors used Noise for their study as it is commonly cited as a trigger for headache, and it has been experimentally validated. The 'white noise' consisted of multiple frequencies similar to an un-tuned television set, at high intensity (but with no threat to the auditory systems of the participants).

The authors conclude:

'Through the study, headache patients reported that they found the noise stimulus more aversive and it resulted in reports of more pain, than non-headache patients ... For individuals who do not suffer from regular headaches, the analyses strongly supported the avoidance theory ... However, for individuals who do suffer from regular headaches, the results were less clear-cut.'

Significantly for those who live near wind turbines and suffer headaches, the authors observe:

'In the 'very long' noise exposure condition, the non-headache group showed further desensitization beyond the 'long' exposure condition whereas the headache group showed sensitization relative to the 'long' exposure condition.'

However:

*'The findings from individuals who suffer from regular headaches do not provide clear guidance as to whether avoidance or exposure to trigger factors is a better strategy from the perspective of desensitization/sensitization. **The data hint at the possibility that for the trigger factor of noise, 'long' exposure may be helpful but 'very long' exposure may be unhelpful.** This paper has argued for the potential benefits of exposure to triggers **but it seems likely that exposure at too high a level will be counterproductive.**' [emphasis added]*

62 On 17 January 2007, The Planning Inspectorate dismissed an appeal to allow two wind turbines at Penpell Farm, Par, Cornwall, near Lanlivery, UK. The Inspector cited these four as among the most significant considerations:

- i. The impact upon the landscape, a nearby World Heritage Site, ancient monuments, and listed buildings;
- ii. The impact on the quality of life, including the visual and noise effects on those who would live near the wind turbines;**
- iii. The impact upon the local economy, including tourism, recreation, and a local day centre for the disabled;
- iv. The benefit of the proposal to meet Government, Regional, County, and local policy aims for renewable energy.
(emphasis added)

However, critical issues also revolved around the health concerns for a boy with severe autism, who lives with his family in a home that would have been one of the nearest to the wind turbines, as well as the health concerns for the attendees of the day centre for the disabled.

The Inspector concluded that the young man would face serious difficulties adapting to the presence of the wind turbines, which would then have serious consequences and hardship for the family, who are the caregivers:

'... there is likely to be harm, and that these are exceptional circumstances that carry some weight as a material consideration against the appeal proposal.'

[The Planning Inspectorate, Bristol. Appeal Decision, by RD Hiscox. Appeal ref: APP/Q0830/A/05/1189328, Penpell Farm, Par, St Austell, Cornwall, PL24 2SA, 17 January 2007]

- 63 It appears that those living near wind turbines and experiencing sleep disturbance, headache, migraine, and/or anxiety and the accompanying physiologic effects are enduring adverse health effects outside their sphere of control. To reiterate the advice of health professional organisations, e.g., the French National Academy of Medicine; health professionals, researchers, and reports such as UKNA's *Location, Location, Location*, **wind turbines should be sited no closer than 2km to a place of residence (with some recommending even greater separation, i.e., 2.4 km).**

- 64 Indeed, after learning about Dr Harry's pilot study, media reports of noise problems from wind turbines, and research on the adverse effects of noise on health, Prof Ralph Katz, Chair of the Department of Epidemiology and Health Promotion, New York University (USA), expressed concern that wind turbines had been constructed in close proximity to homes without research into their potential effects on health.

'No one knows the prevalence of health syndromes where there are pockets of people living next to turbines, so what would be the effects where there are clusters?'

In 2004, Prof Katz recommended a two-year moratorium on wind turbine construction near dwellings in order 'to allow for a multi-disciplinary team of scientists to research all the health and environmental concerns.' [Young N. Wind power debate blows near and far. Western Morning News, 23 January 2004] A two-year moratorium would give epidemiologists enough time to gather and analyse data in order to determine if there is a causal link, although research beyond two years may be required. Moreover, this would avert needless adverse health impacts and an additional burden on the National Health Service in 15 to 20 years time. [Katz R. Personal communication, 3 February 2007]

- 65 According to Deepak Prasher, Professor of Audiology at the Ear Institute of University College London:

'Noise not only annoys, it causes stress that can have an impact on our health and well-being. It can lead to anxiety, sleep problems, communication difficulties, even cardiovascular and immune changes, of which, the individual is usually unaware.' (emphasis added)

[Prasher D. Widex Noise Report: traffic noise in England 2007. University College London (UK) and Widex, January 2007, www.widex.co.uk]

- 66 Wind turbines are not only a matter of renewable energy policy, but also – and no less significantly – a matter of public health policy.

The World Health Organisation's Guidelines for Community Noise 1999 included these recommendations:

Governments should “include noise as an important issue when assessing public health matters and support more research related to the health effects of noise exposure.

Municipalities should develop low-noise implementation plans.

Governments should support more policy-relevant research into noise pollution

Development of continuous monitoring systems for direct health effects in critical locations.

Development of instruments appropriate for local/regional surveys of people's perceptions of their noise/sound environments.

Procedures for evaluating the various health effects of complex combined noise exposures over 24 hours on vulnerable groups and on the general population.

- 65 The WHO report also recommended further research related to direct and/or long-term health effects:

Identification of potential risk groups.

Studies of dose-response relationships for various effects.

Studies on the perception of control of noise exposure, genetic traits, coping strategies and noise annoyance as modifiers of the effects of noise on the cardiovascular system, and as causes of variability in individual responses to noise.

Knowledge on the health effects of low-frequency components in noise and vibration.

Studies on the influence of noise-induced sleep disturbance on health, work performance, accident risk and social life.

Development of a methodology for the environmental health impact assessment of noise that is applicable in developing as well as developed countries.

Studies to assess the effectiveness of noise policies in maintaining and improving soundscapes and reducing human exposures.

- 66 Thus, the evidence strongly supports those who complain of adverse health effects when living within close proximity of wind turbines, particularly the impacts from noise and shadow flicker/strobe effects. Their symptoms parallel those found in other areas of research into the physiologic and medical impact of noise on people. Various noise characters, low frequency noise, infrasound, and shadow flicker, all delivered with a pulsating character, over a prolonged period, pose health risks when developers site wind turbines too close to homes.

Section 6.0 HUMAN RIGHTS

1. Landowners have many rights pertaining to their property, but there are legal restrictions, requirements, and liabilities. A property related activity that produces an environmental pollution escaping onto a neighbour's property, causing a mischief and health problems, may trigger an interference with Article 8 of the European Human Rights Act, enacted in the UK as The Human Rights Act 1998. In the UK, a liability may arise in Tort (Rylands v Fletcher). The Environmental Protection Act 1990 (Part 3) may trigger a Statutory Nuisance. This Section of the review looks at the European Community Human Rights Act as a measure of acceptability of the level of violation and in particular considers its application to the UK.
2. In a speech to the Human Rights Lawyers Association in London on 29 September 2006, Lord Falconer of Thornton, Constitutional Affairs Secretary and Lord Chancellor, said:

“We in government will campaign passionately and defiantly for human rights for everyone in Britain. Because we believe it is the foundation of both our security and our prosperity.”

“It (Democracy) is an acceptance of the values of equality, tolerance and freedom. We are all equal. We are all entitled to have our individual freedoms protected. We can only safeguard our democracy and our freedoms by the rule of law. Those values must be protected and given effect by law.” The freedoms set out in the European Convention on Human Rights reflect those values. They are not the property of lawyers.”

3. In discussing UK Government departments' responsibilities, the Lord Chancellor said:

“In essence this involves ensuring an individual's human rights addresses the issues of possible infringement, justification and proportionality.”

4. Environmental Pollution becomes significant when the pollution threatens or affects people's health. The UK is party to many Policy initiatives that give a high priority to environmental issues. For example, Article 37 of the European Union's Charter of Fundamental Rights provides:

“A high level of environmental protection and the improvement of the quality of the environment must be integrated into the policies of the Union and ensured in accordance with the principle of sustainable development.”

These principles are based on Articles 2, 6, & 174 of the EC Treaty.

5. Increasingly, noise is recognized as a serious environmental problem. For example, EC Directive 2002/49/EC states: *“Whereas: (1) It is part of the Community Policy to achieve a high level of health and environmental protection, and one of the objectives to be pursued is protection against noise. In the Green Paper on Future Noise Policy, the Commission addressed noise in the environment as one of the main environmental problems in Europe.”*

The Human Rights Act and Environmental Pollution.

6 There are two areas of the Human Rights Act 1998 that particularly address Environmental Pollution:

i) Article 8, Right to Respect for Private and Family Life

- a) *Everyone has the right to respect for his private and family life, his home and his correspondence.*
- b) *There shall be no interference by a public authority with the exercise of this right except as in accordance with the law and as necessary in a democratic society in the interests of... the economic well-being of the country for the protection of disorder or crime, or for the protection of health or morals, or for the protection of the rights and freedoms of others.*

7 Article 8 is a Qualified right, i.e., it can be interfered with if the interference is justified. The interference:

- i. must be **lawful** (e.g., decisions that the planning acts allow);
- ii. must serve one of the **legitimate aims** in Article 8 (2); and,
- iii. must be **proportionate**.

The **Legitimate aims** under Article 8 (2) include:

- i. National security,
- ii. Economic well-being,
- iii. Prevention of disorder or crime,
- iv. Protection of health or morals,
- v. Protection of rights and freedoms of others, e.g., the right of a developer to develop his own land and the right of a neighbour to be protected from noise nuisance, and,
- vi. Protection of environment and the interests of the community.

Proportionality must consider:

- i. Is the interference the minimum necessary to achieve the legitimate aims being pursued?
- ii. Has a fair balance been struck?
- iii. Interference with a human right must go no further than is strictly necessary in a pluralistic society to achieve its permitted purpose; or more succinctly, must be appropriate and necessary to its legislative aims.

8. **ii) Article 1 of the First Protocol, Protection of Property.**

- a) *Every natural or legal person is entitled to the peaceful enjoyment of his possessions. No one shall be deprived of his possessions except in the public interest and subject to the conditions provided for by law and by the general principles of international law.*
- b) *The preceding provisions shall not in any way impair the right of the State to enforce such laws as it deems necessary to control the use of property in accordance with the general interest or to secure the payment of taxes or other contributions or penalties.*

- i. Article 1 of the First Protocol is a qualified right;
- ii. Property and possessions include land, rights, planning permissions, licences and goodwill (business);
- iii. Everyone is entitled to peaceful enjoyment of his possessions;
- iv. Prevention of development may infringe the right;
- v. Diminution in value of property may be relevant; and,
- vi. Justification for interference:
 - a. must be lawful,
 - b. must serve one of the legitimate aims in the Article, and,
 - c. must be proportionate.

9. Are there circumstances when a wind turbine, or a cluster of wind turbines, will be a violation of the Human Rights Act? The European Court of Human Rights is the final arbiter of this question, but there are a number of important considerations of fact that should be addressed, and Case Law provides a lead as to how the Court might consider the question.

Evidence supports the proposition that wind turbines create environmental noise pollution, posing a serious health risk to families where wind turbines are built too close to their homes.

10. **Section 3** of this Review, “**The Overview of the Problems**”, reviews the nature of the impacts on people’s lives where wind turbines are built too close to their homes.

The common complaints in response to the noise of wind turbines include: sleep deprivation, fatigue, depression, insomnia, headaches, inability to concentrate, agitating – frustrating – annoying (no escape, infrequent remission, unpredictability of noise), all of which trigger more serious health problems.

11. **Section 4** of this Review, **Acoustics**, reviews research and reports on acoustic radiation from wind turbines. The papers reviewed indicate that UK acousticians working in the wind industry seem to have concentrated their studies upon audible sound. The research and reports confirm that it is the combination of audible sound, infrasound, and vibration, in a pulsating character, that appear to trigger serious reported health problems in those families living near wind turbine installations.

The health problems appear to be aggravated when at certain times of the year strobing light and shadow flicker from the rotating blades projects at the same pulsation rate as the noise. The UKNA report, *Location, Location, Location* [August 2006], which considered both acoustic and medical advice, concluded:

“It would be prudent that no wind turbine should be sited closer than 1 mile away from the nearest dwellings. This is the distance the Academy of Medicine in Paris is recommending, certainly for the larger turbines and until further studies are carried out. There may even be occasions where a mile is insufficient depending on the scale and nature of the proposed development.”

Wind turbines located too close to dwellings will cause environmental noise pollution.

12. **Section 5** of this Review, **Health Effects**, reviews research and reports on Health. The medical research included in this section is international in scope; most of the citations were retrieved via the databases of the US National Library of Medicine (The National Institutes of Health, Bethesda, Maryland, www.nlm.nih.gov), with additional citations from the major engineering and biologic science databases, e.g., Web of Science. These resources are among the most comprehensive and authoritative available, and articles were published in peer-reviewed journals.

Among the findings of the effects of noise on health, sleep deprivation emerges as a significant factor, which is likely to trigger more serious medical conditions. Some of the physiological changes may be cumulative or irreversible, which can have critical consequences not only in terms of individual health, but also in terms of community health, when the source of the problem is community-based.

The Courts appear to acknowledge that health, as a state of physical, mental and social well-being, is a precondition to any meaningful privacy or intimacy, and inseparable from it. The Courts also recognise that sleep deprivation is a serious condition to the extent that it might be considered as an element of inhuman and degrading treatment under Article 3. In *Ireland v The United Kingdom*, the Court held that: "...holding the detainees in a room where there was a continuous loud and hissing noise ..." constituted inhuman and degrading treatment.

- 13 The cause of the violation is shown but the **Legitimate Aims, Article 8 (paragraph 7 above)** need to be considered:

i) **National Security:**

The National Security of a country is not going to be impacted if an onshore wind farm is not built. In fact, it may be argued that because the flow of electricity from a wind farm to the National Grid is not in the control of the Nation, but subject to the control of the weather, in a National emergency the supply of electricity from an onshore wind farm can never be relied upon. Furthermore, electricity flowing to the National Grid from a wind farm is neither secure nor reliable in delivery.

- 14 ii) **Economic Well-being:**

The viability of the National Economy will not be impacted if an onshore wind farm is not built. The National Audit Office have questioned the viability of the ROC (Renewable Obligation Certificate), introduced by the State, which provides the attractive financial investment returns to onshore wind farm developers; moreover, the system is not providing value for money to the consumer. [National Audit Office, Auditor General, HC624 Session 2002-2003. The New Electricity Trading Arrangements in England and Wales, 9 May 2003; also NAO HC 210 session, 2004-2005, 11 Feb 2003] Many argue the introduction of ROCs has been an important influence in stimulating rising electricity prices to consumers, which in turn contributes to increasing inflation which is not in the economic well-being of the country. [Refer also to

Renewable Energy Foundation (REF) The Oswald Research, 2006; also REF submission to the Yelland Wind Farm, Devon, Planning Appeal, 2 April 2006]

In 2006, Professor James Lovelock captured the attention of the international community with his book on global warming, 'The Revenge of Gaia'. On page 83, he comments:

'According to the Royal Society of Engineers' 2004 report, onshore European wind energy is 2 – 5 times, and offshore wind energy over 3 times, more expensive per kilowatt hour than gas or nuclear energy. No sensible community would ever support so outrageously expensive and unreliable an energy source were it not that the true costs have been hidden from the public by subsidies and the distortion of market forces through legislation.'
[Lovelock J. The Revenge of Gaia: Why the Earth is Fighting Back – and How We Can Still Save Humanity. Allen Lane (Penguin), 2006]

The Dti Report "Our Energy Challenge 2006" refers to the work of Prof David Simpson in his April 2004 report for the David Hume Institute. The Paper: "Tilting at Windmills: The Economics of Wind Power" (No. 65), states:

"At the present time the cost of generating electricity from wind power is approximately twice that of the cheapest alternative conventional cost."

"But projections by Government advisers, using relatively optimistic assumptions, show that even by the year 2020 a generation portfolio containing 20% wind power will still be more expensive than a conventionally fuelled alternative."

"No matter how large the amount of wind power capacity installed, the unpredictably variable nature of its output means that it can make no significant contribution to the security of energy supplies."

There is no evidence to show that onshore wind power makes any real contribution to the economic well being of the UK. If all the onshore wind turbines in the UK were shut down, there is no evidence that this shut down would have any impact on the National economy.

15 **iii) Prevention of Disorder or Crime:**

This is not influenced by wind farm developments.

16 **iv) Protection of Health and Morals:**

Wind farms built too close to peoples' homes are unlikely to have any impact on peoples' morals, but they do create very real health problems as set out in **Section 5, Health Effects**.

Section 4, of this Review, **Acoustics**, contends that the use of guidance ETSU-R-97 fails to protect families where wind turbines have been built too close to their homes, noting that The World Health Organisation's upper limit for bedroom noise at night offers greater protection to people, family life, and amenity. In considering whether a scheme will be a violation of the Human Rights Act, it is necessary for the decision-maker to seriously consider the advice of The World Health Organisation on standards for Community Noise, as its maximum noise levels are designed to limit noise impact on health.

The WHO limits bedroom noise at night to a **combined (total)** noise level of 30dB, and the level is reduced when low frequency content is present and reduced even further when pulsating noise is present. On windy nights, it is the total noise, including background noise, that enters the bedroom, and that should not exceed the maximum level. The difference in approach between ETSU and WHO probably accounts for much of the sleep deprivation described in **Section 3** of this Review, **Overview of the Problems**.

- 17 In deciding the status of ETSU-R-97 in terms of the Human Rights Act, it is important to remember that the membership of the Committee that produced the ETSU report in 1997, appeared weighted towards members working in or for the wind industry. This may account for the Committee's recommendation of the high level of environmental noise pollution that would have to be suffered by neighbouring families. While admitting the importance of preventing sleep deprivation, the ETSU Committee recommendation was instead weighted at a level that the Committee felt would not restrict the development of wind energy. As a result, it would seem that the Committee tipped the balance disproportionately in favour of wind farm developers over the impact on community quality of life and the protection of the health of people living nearby.

- 18 Case law has shown that the violation is the key factor; and if the State has a 'bylaw' that fails to provide adequate protection, then the State remains liable.

The Minutes of the new ETSU-R-97 Noise Working Group, (Committee formed by the State and chaired by the State), dated 02 August 2006, fails to mention any discussion on:

- 1) The need to comply with The Human Rights Act
- 2) The World Health Organisation "**Guidelines for Community Noise 1999**"
- 3) The Report from the National Academy of Medicine, France (March 2006)
- 4) The Report by the United Kingdom Noise Association "**Location, Location, Location**" (Aug 2006).

Evidence shows that families suffer sleep deprivation and other health problems when wind turbines are built too close to dwellings; this is indicative of the State failing to provide adequate health protection. Interference to this extent is not justified.

- 19 v) **Protection of Rights and Freedom of Others:**
Clearly, the site owner has the right to develop his land in accordance with the provisions of the County and Local Development Plans under the Town Planning Acts.

However, apart from arguments of a Town Planning nature, the landowner has to recognize that the neighbours also have rights. The development of land that creates an environmental noise pollution, which escapes onto a neighbour's land, may create a violation of the Human Rights Act 1998, as well as an infringement of The Environmental Protection Act, and the nuisance might be classed as a strict liability in Tort (*Rylands v Fletcher*).

- 20 Regarding a wind farm, it is incumbent on the site owner to produce a layout design that prevents or limits to reasonable levels the environmental pollution entering the neighbours' properties, which is most likely achieved by ensuring a suitable distance between the noise source and the neighbours' properties.

The landowner may argue that the State has set Guidance on the level of noise pollution that the State believes is at an acceptable level to neighbours. However, compliance with these Guidance levels may not satisfy the Human Rights Act. The status of the Guidance is worth considering:

Planning Policy PPG24: Planning & Noise – General principles (2), states: *“The Planning system has the task of guiding development to the most appropriate locations. It will be hard to reconcile some land uses, such as housing, hospitals and schools, with other activities which generate high levels of noise but the Planning system should ensure that, wherever practicable, noise sensitive developments are separated from major sources of noise (such as road ... and certain types of industrial development). It is equally important that new development involving noisy activities should, if possible, be sited away from noise sensitive land uses.”*

Planning Policy Statement 22 (2004) S.22 ‘Noise’, states: *“Renewable technologies may generate small increases in noise levels ... Local Planning authorities **should** ensure that renewable energy developments have been located and designed in such a way to minimize increases in ambient noise levels ... The 1997 report by ETSU for the Dti **should** be used to assess and rate noise from wind energy developments”.*

The use of the word “**should**” – rather than the phrase ‘will be used’ – allows the decision maker to use ETSU-R-97 together with any other relevant considerations.

- 21 vi) **Protection of the Environment and the Interests of the Community.** The attempt to reduce one form of pollution (carbon) by the creation of a new pollution (noise pollution) and visual pollution is not credible. (Visual pollution is mentioned because many will argue that a fixed, motionless, wind turbine standing in a field is unlikely to provoke much interest. The moment the blades start to rotate, the structure captures the eye and it has the ability to mesmerize or distract some people.)
- 22 A wind farm does not create new jobs, as one engineer can service a number of wind farms. Rural areas depend mainly on agriculture and tourism as the key employment. Countryside Tourism, by its very title, is supported by people seeking solitude, walking, and a contrast to urban and suburban living. Tourism customers will not find solitude and unspoilt rural landscape where wind farms have industrialised the area. Although some wind farm developers make a token financial contribution to a community, this is ‘de minimus’ compared with the potential loss in property values resulting from the environmental pollution and industrialisation created by the wind turbines. [The Small Business Council. UK Energy Policy: *The Small Business Perspective and the Impact on the Rural Economy*. Report by Whitmill C for the SBC, February 2006] (See also this paper’s **Appendix on Property Values**)

- 23 Referring again to the Report from The David Hume Institute (S6.13), Prof Simpson commented:

“Because of the cost of providing additional stand-by generating capacity, it is unlikely that wind power will ever account for more than 20% of electricity generation through the National Grid. That being the case, its development can make no substantial contribution to an overall reduction in carbon emissions.”

The Dti acknowledges that wind turbines require separate balancing power provided by conventional power stations, in order to balance the flow of electricity to the National Grid. Nuclear power is not suitable because of its slow response time. Conventional power, therefore, provides balancing power in the form of gas, oil, or coal. In the UK, it is normally gas (methane). The construction of onshore wind farms with high volatility in supply of electricity require near similar (MW) balancing power. This has the effect of increasing demand for methane. The transportation of methane has inherent issues, since the leakage is about 4% by volume. **Methane is 24 times more destructive as a greenhouse gas than carbon dioxide.** [Lovelock J. *The Revenge of Gaia*, 2006, pp 74-5]

- 24 Having in mind the similar MW capacity ‘balancing power’ will be constantly fired up, demanding methane gas of which about 4% by volume will disperse into the atmosphere, it is difficult to comprehend how onshore wind farms can be considered as protecting the environment – especially when the noise pollution is added to the equation.
- 25 Many local communities support the production of renewable energy, but they do not support the creation of environmental pollution as an acceptable consequence. Onshore wind turbines built in sparsely populated, wide-open spaces, around the world, cause few noise problems. However, schemes proposed in well-populated areas are those most likely to evoke a huge swell of community objection. In the final equation, the excessive environmental noise pollution escaping onto neighbouring property, plus the visual pollution from the constant rotation of the blades nearby, plus the reliance on back-up balancing power fuelled by methane gas, balanced against a small saving in carbon (using the National power balance rather than coal as the carbon measure), shows the cost imposed on neighbouring families is not justifiable.

Case Law

- 26 The European Court of Human Rights has made it very clear that environmental considerations may involve a breach of Article 8, even after allowing a margin of appreciation to the State.
- 27 In *Lopez Ostra v Spain* (1994) 20 EHRR 2777:
S.51 Naturally, severe environmental pollution may affect individuals well-being and prevent them from enjoying their homes in such a way as to affect their private and family life adversely, without, however, seriously endangering their health.

S.58 Having regard to the foregoing, and despite the margin of appreciation left to the respondent State, the Court considers that the State did not

succeed in striking a fair balance between the interest of the town's economic well-being – that of having a water treatment plant – and the applicant's effective enjoyment of her right to respect for her home and her private and family life.

28 In **Guerra & Others v Italy** (1998) 26 EHRR. 3577:

S.58 The Court considers that Italy cannot be said to have “interfered” with the applicants private or family life: they complained not of an act by the State but of its failure to act. However, although the object of Article 8 is essentially that of protecting the individual against arbitrary interference by the public authorities, it does not merely compel the State to abstain from such interference: in addition to this primary negative undertaking, there may be positive obligations inherent in effective respect for private or family life.

S.60 The Court reiterates that severe environmental pollution may affect individuals well being and prevent them from enjoying their homes in such a way as to affect their private and family life adversely ... The Court holds, therefore, that the respondent State did not fulfill its obligation to secure the applicants' right to respect for their private and family life, in breach of Article 8 of the Convention.

29 In **Fadeyeva v Russia** (June 2005) ECHR 55723

S.64 The applicant alleged that there had been a violation of Article 8 of the Convention on account of the State's failure to protect her private life and home from severe environmental nuisance arising from the industrial activities of the Severstal steel-plant.

S.132 The Court finds the following. The State authorized the operation of a polluting enterprise in the middle of a densely populated town. Since the toxic emissions from this enterprise exceeded the safe limits established by the domestic legislation and might endanger the health of those living nearby, the State established that a certain territory around the plant should be free of any dwelling. However, these legislative measures were not implemented in practice.

S. 133 It would be going too far to state that the State or the polluting enterprise were under an obligation to provide the applicant with free housing, and, in any event, it is not the Court's role to dictate precise measures which should be adopted by the States in order to comply with their positive duties under Article 8 of the Convention. In the present case, however, although the situation around the plant called for a special treatment of those living within the zone, the State did not offer the applicant any further solution to help her move from the dangerous area.

Furthermore, although the polluting enterprise at issue operated in breach of domestic environmental standards, there is no information that the State designed or applied effective measures which would take into account the interests of the local population, affected by the pollution, and which would be capable of reducing the industrial pollution to acceptable levels.

S 134 The Court concludes that, despite the wide margin of appreciation left to the respondent State, it has failed to strike a fair balance between the interests of the community and the applicant's effective enjoyment of her

right to respect for her home and her private life. There has accordingly been a violation of Article 8.

30. In **Moreno Gomez v Spain** (16 November 2004) 4143/02
In this case, the applicant had lived in a residential quarter of Valencia since 1970. In June 1996, the City Council approved a bylaw on noise and vibrations. Article 8 of the bylaw says that in a family residential area (such as the one in which the applicant lives) external noise levels were not to exceed 45 dBA Leq between 10pm and 8am. Article 30 of the bylaw defines ‘acoustically saturated zones’ as areas in which the large number of establishments, activity of the people frequenting them and passing traffic expose local residents to high noise levels and cause them serious disturbance. The applicant was exasperated by the situation, which prevented her from sleeping and resting and caused her insomnia and serious health problems.

S 57 The present case does not concern interference by public authorities with the right to respect for the home, but their failure to take action to put a stop to third-party breaches of the right relied on by the applicant.

S 60 In view of its volume – at night and beyond permitted levels – and the fact that it continued over a number of years, the Court finds that there has been a breach of the rights protected by Article 8.

S 62 In these circumstances, the Court finds that the respondent State has failed to discharge its positive obligation to guarantee the applicants right to respect for her home and her private life, in breach of Article 8 of the Convention.

- 31 The above Cases reveal how the European Court of Human Rights has considered breaches of Article 8 where the root cause of the issue is an environmental pollution. A loss of a view that has triggered a loss in property value has not, in itself, been considered a breach of Article 8 and Article 1 of the First Protocol. This was shown in the Case of **Lough & Ors v Secretary of State and Bankside Developments**, July 2004, in the UK Court of Appeal, before Pill LJ, Keene LJ, and Scott Baker LJ. The Appellants were objectors to a development proposal that had been permitted following a Planning Appeal. The Appellants submitted that the Inspector had erred, it was claimed, in failing to consider three of the complaints made by the Appellants: loss of a view, interference with television reception during the construction of the proposed building and the diminution in value of 15% to 20% in the properties. The Court of Appeal upheld the previous Court’s decision that there was no breach of Article 8. The Court found the creation of a diminution of value as a separate and distinct breach of Article 8 and Article 1 of First Protocol was not proven.
- 32 However, diminution in value has been an important consideration when noise pollution is the interference: In **Dennis and Dennis v Ministry of Defence** (2003) EWHC 793 (QB), Mr Justice Buckley found an interference with the Convention rights of the Claimants whose enjoyment of their home (and its value), Walcott Hall, was impaired by the noise of overflying Harrier jets during pilot training exercises from nearby RAF base at Wittering. Also in **Hatton v UK** (2003) 37 EHRR 288, the Court had to consider, in the context of Article 8, the level of noise caused by night flights at Heathrow Airport and its effect on nearby residents.

In S.96:

Article 8 protects the individual's right to respect for his or her private and family life, home and correspondence. There is no explicit right in the Convention to clean and quiet environment, but where an individual is directly and seriously affected by noise or other pollution, an issue may arise under Article 8.

- 33 The **Hatton** judgment also clarifies the nature of the State – or regulatory authority's "positive obligations" to regulate private parties and the balancing exercise it is called upon to perform.

S118: It is clear that in the present case the noise disturbance complained of were not caused by the State or State organs, but that they emanated from the activities of private operators. It may be argued that the changes brought about by the 1993 Scheme are to be seen as a direct interference by the State with the Article 8 rights of the persons concerned. On the other hand, the State's responsibility in environmental cases may also arise from a failure to regulate private industry in a manner securing proper respect for the rights enshrined in Article 8 of the Convention. As noted above (S98), broadly similar principles apply whether a case is analysed in terms of a positive duty on the State or in terms of an interference by a public authority with Article 8 rights to be justified in accordance with paragraph (2) of the provision... The question is whether, in the implementation of the 1993 policy on night flights at Heathrow airport, a fair balance was struck between the competing interests of the individuals affected by the night noise and the community as a whole.

- 34 Mr Justice Buckley in **Dennis & Dennis v MOD [2003]** made a further point on "proportionality". The decision established an important principle in domestic law in relation to proportionality and compensation. First, he found that the evidence of severe noise nuisance and consequent loss in value of the estate established an interference with both Article 8 and Article 1 of the First Protocol. In these circumstances, he held that a fair balance would not be struck in the absence of compensation.

"I believe it is implicit in the decision S v France, that the public interest is greater than the individual private interests of Mr and Mrs Dennis but it is not proportionate to pursue or give effect to the public interest without compensation for Mr and Mrs Dennis ... in my view, common fairness demands that where the interests of a minority, let alone an individual, are seriously interfered with because of an overriding public interest, the minority should be compensated."

- 35 Without an acceptable scheme for compensating those directly or seriously affected by the noise and economic loss, a proposed development of wind turbines cannot be said to achieve a fair balance, as per **S v France**. As a consequence, if there is a violation of Article 8, it follows there is most likely to be a violation of Article 1 of the First Protocol, and it is submitted that the damage will flow from the escape of the environmental noise pollution plus an element of value directly attributable to the visual pollution (flicker/strobing).

36 **Justification for Interference**

Once an interference with the families' Convention rights is considered likely, the question is then whether that interference can be justified in order to avoid a violation of the Convention right. To justify the interference it must be shown to be "in accordance with the law and ... necessary in a democratic society" in the interests of one of the recognized categories listed in Article 8(2) or in the public interest under Article 1 of the First Protocol. It is accepted that if the decision makers for the State approved the development by granting a Planning permission, in accordance with the Town and Country Planning Act, it would be in accordance with the law. However, the development may not satisfy other elements of justification.

- 37 The interference might be "necessary in a democratic society" only if:
- a) It was in response to a pressing social need; and,
 - b) It involved no greater interference than required to address that need (this is the proportionality principle).

38 It is difficult to see how a wind farm development satisfies any of the Article 8(2) social need categories: "national security, public safety, the economic well-being of the country, the prevention of disorder or crime, the protection of health or morals or for the protection of the rights and freedoms of others".

39 The stated purpose of most wind farm developments is to promote renewable energy in order to reduce carbon emissions and thus protect the global environment. Conceivably this could involve protecting the rights or freedoms of others, but it would be a weak claim and not sufficient to justify interfering with an individual's valuable rights of privacy under the Article 8.

Moreover, it could be argued that the wind turbine developer could attain the same goal of reducing carbon emissions, with an increased buffer zone between homes and the wind turbines. Thus, the developers' and communities' needs would both be met.

Other options might include using smaller wind turbines, fewer wind turbines, controlling blade rotation speed, and turning them off at night.

40 Whether onshore wind turbines satisfy the "public interest" requirement of Article 1 of the First Protocol is a separate question. It is arguable that the wind turbines do not satisfy primary Government Energy Policy and are therefore not in the public interest.

41 Government Policy, as set out in the Energy White Paper [Dti. *Energy White Paper: Our Energy Future: Creating a Low-Carbon Economy*. Dti: London, 2003], strives to maintain the "**reliability of energy supplies**" (S. 1.18.) and states that "**reliable energy supplies are fundamental to the economy as a whole and to sustainable development. An adequate level of energy security must be satisfied at all times in both the short and long term futures.**"

42 The national importance of reliability in energy supply is taken forward in “*Our Energy Challenge*”, the Dti consultation document issued in 2006. The State set several goals for the country’s energy supply:

- a. “*To maintain the reliability of energy supplies.*” [p 11, S.1]
- b. “*The Regulatory framework must give high priority to reliability.*” [p 32, S.2.2.2, Reliable energy supplies]
- c. “*Maintaining the reliability of electricity supplies will require very substantial levels of new investment ...*” [p 50, S.3.1., Looking ahead]

The key feature of onshore wind generation is its total unreliability in the supply of electricity. Furthermore, because the Dti 2006 document is a major review of UK energy policy, within its 72 pages, there is little mention of onshore wind power, which demonstrates just how insignificant it is to the State as a future electricity-generating source.

43 Furthermore, in his report, “*Power to the People*”, Professor MA Laughton noted the innate unreliability of wind as a secure source of energy:

“... a more detailed examination of one aspect is necessary, namely that concerning the interaction of random, intermittency of supply with security, bearing in mind that security of electricity requires continuity of power delivery, not energy.”

“Large weather systems, particularly high pressure windless systems, can cover most of the country, as seen during the January 2003 cold spell for several days and again during the subsequent July heatwave. At such times the contribution from any wind ... are severely curtailed.”

[Laughton MA. *Power to the People: future-proofing the security of UK power supplies.* ASI Adam Smith Institute, London 2003]

44 The unreliability of electricity supply and flow from wind turbines is further emphasised in the following reports:

- a) “*An Engineering Appraisal of the PIU Energy Review*”, The Royal Academy of Engineering for the Energy Minister, August 2002; and,
- b) “*Energy at the crossroads, The Chemical Engineering Contribution to the UK Energy Debate*”, The Institution of Chemical Engineers for the Energy Minister, September 2002.

45 The generation of electricity from wind turbines depends entirely upon the weather. Because this resource is uncontrollable by man, the electricity flow is unreliable and unpredictable. In failing to provide a reliable and secure electricity supply, wind turbine generation thus does not comply with Government Energy Policy.

- 46 It is however necessary to recognize that the Dti Energy Review [2006] supports offshore wind farms because firstly the wind offshore is more reliable than onshore wind, thereby producing substantially higher effective electricity generation. Secondly, an array of several hundred wind turbines linked to a central collecting pod on the seabed can feed electricity by a single cable to the shore, where a hydrogen generation plant could be located. With a large hydrogen storage capacity, this hydrogen plant would then generate electricity by burning hydrogen in a controlled, reliable, and sustainable form supplying electricity directly to the National Grid. This combination only then meets the National Policy for the reliability and security of electricity supply, i.e., the source of electricity supply is from hydrogen storage.
- 47 It is also necessary to recognize that the Dti Energy Review supports onshore solace wind turbines serving an industrial unit, commercial premises and small communities. This works because the amount of electricity generated is ‘de minimus’ and destined for direct commercial consumption. This system allows the National Grid to act as provider of balancing power to the industrial/commercial user without disruption to the network supply.
- 48 Wind turbine developers often argue that wind turbines are State Policy. It has not been possible to find documentation to support this proposition. It may be more correct to say that State Policy takes the form of setting targets for renewable energy generation and that industry’s response to meeting these targets is the wind turbine as it is available technology. Furthermore, the State has set targets in the form of ‘installed capacity’, and apparently it matters not to the State that in some locations, actual electricity production on an annualised basis is merely circa 24% of installed capacity. While State Policy clearly identifies ‘reliability’ and ‘security’ of supply as critical objectives, wind turbines will not satisfy this Policy. The EU Court of Human Rights might wonder at the remoteness of wind turbines from fulfilling Policy.
- 49 There is **no justification** in allowing wind turbines to be built so close to peoples’ homes with the result that they fail to meet the noise limitations set out by the World Health Organisation *Guidelines for Community Noise 1999*, a consequence of which is to create serious health damage and a likely violation of the Human Rights Act 1998.
- 50 In considering the question of Tort, it is a well established principle of UK law that if a landowner collects something onto his land that is likely to do mischief if it escapes onto adjoining land; then if it does escape, the landowner is liable for the damage (*Rylands v Fletcher*) (L.R.1. Ex 265, 279 – 80):

“The person who for his own purposes brings on his lands and collects and keeps there anything likely to do mischief if it escapes, must keep it in at his peril, and if he does not do so, is prima facie answerable for all the damage which is the natural consequence of its escape.”

- 51 In the House of Lords, Lord Cairns added that in order for the Rule to apply, the defendant's use of the land must be "non-natural". P James on Law of Torts points out:

"The Rule applies to things likely to do mischief if they escape, e.g. water, gas, electricity, fumes, rusty wire from fencing, explosions.... To give liability there must be an escape from the premises/land."

- 52 The owner of land operating a wind turbine to generate electricity is performing an industrial activity by installing the turbines, collecting the wind, using the wind to manufacture electricity, and discharging the wind (and the resulting wind vortices) over his land. During the manufacturing process, the wind changes its form, velocity, and character, and collects sound characters of its own and in combination with the design and engineering of wind turbines, creates environmental pollution. Over distance, the pollution dissipates and within large sites, the pollution dissipates before leaving the land boundaries. However, on small sites in well-populated areas, the pollution will still be present when the wind – and the resulting wind vortices created by the wind turbines – enters a neighbour's property, mischief is likely to occur with consequent damage to health. The liability may be a strict liability under the Rule of *Rylands v Fletcher* and not covered by indemnities or insurance cover. Cases that are more recent include: *Bottomley v Todmorden*, High Court 2003, and *Transco v Stockport Metropolitan Borough Council*, House of Lords 2003.
- 53 Others have noted that perhaps the wind farm developers' contractual indemnities are qualified by the requirement of proof of negligence and based upon strict liability under *Rylands v Fletcher*, which would mean that in such circumstances liability falls on the landowner.
- 54 The failure of the State to properly protect the health of people from environmental noise pollution that is a consequence of development permitted by the State, is not justified.
- 55 This section considered the application of the EU Human Rights Act, Article 8 and Article 1 of the First Protocol, to the physiological and medical suffering of families caused by a decision by the State that allows developers to build wind turbines too close to homes. The weakness of the Human Rights Act is exposed by the fact that decision makers of the State rely on the argument 'balance in favour of the State', to justify serious violations of family to the right of respect for private and family life. Yet applying the dictum of Justice Buckley (S.6.34), if the State considers wind turbines are public policy, then the 'minority' interest should be compensated. If wind turbines are not State policy, then decision makers may be challenged when they use the 'balance in favour of the State' to justify giving an approval that risks a violation of basic Human Rights.

The UK Lord Chancellor has said that:

"We in Government will campaign passionately and defiantly for human rights for everyone in Britain. Because we believe it is the foundation of both our security and our prosperity." [S. 6.02]

On 10 May 2006, The British Consulate, New York, sent an email entitled, "*UK Elected to UN Human Rights Council*". The last paragraph states:

"The UK remains committed to striving for the highest standards of human rights both at home and around the world. We are committed to fulfilling the detailed pledges we made as part of our election campaign to promote and protect human rights in the UK and globally. We will play the fullest part in making the new Human Rights Council a success."

It is for the reader to judge the evident disparity between the words and the deeds of the UK State when it permits developers to build wind turbines too close to dwellings. The disparity might possibly be explained by the enthusiasm of Departments of State to achieve renewable energy targets set by the State, and in order to achieve those targets, treat the Human Rights Act as an obstacle to circumvent.

Peter Hadden

[Note: Sentences emboldened within quotations are the author's emphases.]

Section 7.0 CONCLUSION

The environmental noise pollution from wind turbines built too close to dwellings causes serious discomfort, and often health injury, to families. Oftentimes those affected did not object to the construction, accepting the developer's assurances that noise would not be problematic.

Section 4 of this Review, **Acoustics**, explores the research on noise radiation from wind turbines. Locating wind turbines close to families demands a precision, accuracy, and certainty of acoustic prediction and calculation that is just not available to the wind energy engineers and acousticians. The ETSU-R-97 Noise Working Group (UK) concluded that it would be too restrictive on wind farm developments to provide the protection necessary [i.e., to prevent sleep deprivation].

The challenges in designing a predictive model for wind turbine noise are complex. Factors include the very nature of wind turbine design itself, e.g., the rotation of the blades through the air, each passing the tower rhythmically, creating a characteristic pulsating sound as well as a vortex of air; moreover, there is an interaction among the turbines, so the placement of each turbine within an array can influence noise emission. Other factors include the constantly changing atmosphere and wind speed, temperature, and terrain. Noise, particularly low frequency noise, travels not only seismically but also airborne over terrain. On occasion, the local geography can act like a giant microphone. Thus, when wind turbines are located too close to dwellings, their noise may have an adverse impact on residents, because the methods and models used to predict wind turbine noise have distinct design limitations.

The result is an adverse impact not only to quality of life, but those who live near wind turbines may also suffer adverse health effects. Research links noise to adverse health effects, e.g., sleep deprivation and headache. Sleep deprivation itself may lead to physiologic affects, such as a rise in cortisol levels, a sign of physiologic stress, as well as headache, mood changes, and inability to concentrate. Initial research into the health impact of wind turbine noise (including the 'visual noise' of shadow flicker) reveals similar findings. Indeed, while many studies in work environments or laboratory simulations confirm these responses, those living near wind turbines endure continuous, long-term exposure.

Thus, the personal and media reports, emerging clinical evidence, and published research combine to offer urgent and compelling reasons for Government to reconsider policy on wind turbine developments. Several reports offer guidance, including the World Health Organisation *Guidelines for Community Noise 1999*; the UK Noise Association's report, *Location, Location, Location* (2006); and the statement by the French National Academy of Medicine (2006).

These are also compelling reasons for the Government to seek expert independent medical advice and epidemiologic research to assess the health impacts in order to prevent additional injury and to redress the injury to those already affected. Indeed, to express this more forcefully: The question the Government must address is whether they – the Government – are prepared to knowingly subject its people to substandard conditions when these could easily have been avoided, e.g., by following the level of health protection advised by the World Health Organisation *Guidelines for Community Noise 1999*.

Although the Government may conclude that they must wait for the scientific evidence to unfold, this approach ignores those many families – and those who will unfortunately and inevitably follow – who are experiencing genuine distress, and whose predicament could so easily have been avoided.

As this is a matter of public health policy, proceeding with wind turbine developments and applications that violate the public's health may also be a violation of the Human Rights Act by the landowners, the wind turbine developers, and the State.

The Review addresses the issue of Human Rights in Section 6. Although European States have 'Bylaws' or 'Guidances' and the United States has 'Ordinances' that provide guidance to Planning decision makers, in the final analysis it is contended that the responsibility of the decision maker is not merely to seek compliance with a Bylaw/Guidance/Ordinance in arithmetical terms, but also to establish beyond reasonable doubt that the families' right to respect for their homes and their private lives is not violated. If the State decides that the public interest in building wind turbines is greater than the individual private interest, then the violation is not proportionate without compensation for the individual (S6.34).

RECOMMENDATIONS:

- The Government would be prudent to institute an immediate and mandatory minimum buffer of 2km between a dwelling and an industrial wind turbine, and with greater separation from a dwelling for a wind turbine with greater than 2MW installed capacity.
- There is a need for a multidisciplinary team of experts – independent of the wind energy industry – to assess clinically and to investigate epidemiologically, the health impacts on people where industrial wind turbines have been located too close to their dwellings.
- Governments are appealing to the social and ethical conscience of commerce to become carbon neutral and mitigate the effects of global warming. In an appeal to the ethical and social conscience of bankers and investment institutions, we recommend that before providing finance to wind turbine developments that are near family homes, the Investors should demand from the developers a Guarantee Bond that unreservedly guarantees that the operation of the wind turbines will not violate the families' right to respect for their homes and private lives. This would be a prudent caution to take in order to lessen the risk of potential environmental and medical claims at some future time.

REFERENCES

Note: Web addresses are accurate as of January 2007. However, the authors cannot guarantee that these links will remain active or accurate.

Aitch I.

Keep it down.

Telegraph [UK] Magazine, 2 December 2006.

Babisch W.

The noise/stress concept, risk assessment, and research needs.

Noise and health 2002; 4(16): 1 – 11.

Babisch W.

Stress hormones in the research on cardiovascular effects of noise.

Noise and health 2003 Jan-Mar; 5(18): 1 – 11.

Barber M.

Letter to Energiekontor AG (Germany).

Bradworthy, Devon, UK: 12 July 2005.

Bell A.

Noise: an occupational hazard and public nuisance.

Geneva: World Health Organization, 1966.

Bengtsson J; Persson Waye K; Kjellberg A.

Evaluation of effects due to low-frequency noise in a low demanding work situation.

Journal of sound and vibration 2004; 278(1/2): 83 – 99.

Berglund B; Hassmen P; Soames Job RF.

Sources and effects of low-frequency noise.

JASA Journal of the acoustical society of America 1996 May; 99(5): 2985 – 3002.

Bolton R.

Evaluation of Environmental Shadow Flicker Analysis

for “Dutch Hill Wind Power Project”.

Environmental Compliance Alliance, New York, USA, 30 January 2007.

Bowdler D.

ETSU-R-97: why it is wrong.

New Acoustics, July 2005.

Brierley D.

Public presentation.

Askam, Cumbria, UK, 2006.

The British Consulate, New York, New York, USA.

UK elected to UN Human Rights Council.

The British Consulate, e-mail newsletter, 10 May 2006.

Bunker RJ, ed.
Nonlethal weapons: terms and references.
USAF Institute for National Security Studies, INSS Occasional Paper 15.
Colorado (USA): United States Air Force INSS, July 1997 www.usafa.af.mil/inss .

Burkhardt G.
Complaints are not new.
Wales, UK: Journal, <http://www.thisissouthwales.co.uk> , 1 June 2005.

Castelo Branco NA; Rodriguez E; Alves-Pereira M; Jones DR.
Vibroacoustic disease: some forensic aspects.
Aviation, space, and environmental medicine 1999 Mar; 70(3 Pt2): A145 – 151.

Chouard C-H.
Le retentissement du fonctionnement des eoliennes sur la sante de l'homme
[Repercussions of wind turbine operations on human health].
French National Academy of Medicine.
Panorama du medecin, 20 March 2006.

Couple driven out of home by wind farm.
Spalding Today, 21 December 2006,
<http://www.spaldingtoday.co.uk/ViewArticle2.aspx?SectionID=829&ArticleID=1941028>

Crespo A; Hernandez J; Frandsen S.
Survey of modelling methods for wind turbine wakes and wind farms.
Wind energy 1999; 2: 1-24.

The cutting edge: military use of sound.
Toronto Star [Canada], 6 June 2005.

The Darmstadt Manifesto.
Germany: German Academic Initiative Group, 1998.

Davis J.
Personal communication, 19 January 2007.

Defra (Department of the Environment, Farming, and Rural Affairs).
Low frequency noise.
Consultation report by Casella Stanger, Technical research support for Defra Noise Programme.
Defra [UK], 2001.

Defra.
Proposed criteria for the assessment of low frequency noise disturbance.
Consultation report by Dr Andy Moorhouse et al.
Defra [UK], February 2005.

'Did turbines make you sick?'
Wales, UK: Journal, <http://www.thisissouthwales.co.uk> , 18 May 2005.

Drummond PD.
Sensitivity to light and noise in tension-type and cervicogenic headache.
Cephalalgia 1998; 18: 303.

Dti (Department of Trade and Industry, UK).
Energy white paper: our energy future: creating a low-carbon economy.
Dti, 2003.

Dti executive summary of the measurement of low frequency noise at three UK wind farms, contract number W/45/00656/00/00, URN number 06/1412, Contractor: Hayes McKenzie Partnership Ltd, 2006.

Dti.
Our energy challenge 2006.
Dti, 2006.

Dti Noise Working Group.
ETSU-R-97.
Dti 1997.

Energiekontor AG (Germany)
Letter to M Barber.
19 July 2005.

Ervin K.
Letter to 'Interested Parties'.
Meyersdale, Pennsylvania, USA, <http://www.pbase.com/wp/image/39285457> ,
7 March 2006.

European Union.
Charter of Fundamental Rights of the European Union.
Official journal of the European communities 18.12.2000 EN 2000/C364/01,
http://ec.europa.eu/justice_home/unit/charte/index_en.html .

Flurry of complaints after wind change.
New Zealand: TV1 News <http://tvnz.co.nz/view/page/411749/599657> , 25 July 2005.

Garrett A.
Ugly side of wind power.
The Observer [UK], Sunday, 2 March 2003.

Glegg SAL, Baxter SM, and Glendinning AG.
The prediction of broadband noise from wind turbines.
Journal of sound and vibration 1987; 118(2): 217-39.

Gregg N.
Wind energy not resident-friendly.
Queensland, Australia: The Courier-Mail, 4 October 2005.

Griefahn B; Spreng M.
Disturbed sleep patterns and limitations of noise.
Noise and health 2004 Jan-Mar; 6(22): 27 – 33.

Harry A.
Wind Turbines, Noise and Health.
www.windturbinenoisehealthhumanrights.com, 2007.

- Hedge A.
Whole body vibration [course description, DEA350].
Cornell University, April 2002, c January 2006.
- Herlihy M.
Windmills 'are a nightmare'.
The Corkman [Ireland], 6 April 2006.
- Hubbard HH.
Noise induced house vibrations and human perception.
Noise control engineering 1982; 19(2): 49 – 55.
- Hubbard HH; Shepherd KP.
Aeroacoustics of large wind turbines.
JASA Journal of the acoustical society of America 1991 June; 89(6): 2495 – 2508.
- Hubbard HH; Shepherd KP.
Wind turbine acoustics.
NASA Technical Paper 3057, December 1, 1990.
NASA National Aeronautics and Space Administration, Langley Research Center,
Hampton, Virginia (USA), Document ID 19910007366, DOE/NASA/20320-77,
www.sti.nasa.gov/products.html#db or <http://ntrs.nasa.gov/search.jsp> .
- Hutzell RA Jr.
Letter.
Meyersdale, Pennsylvania, USA: <http://www.pbase.co/wp/image/39285457> ,
13 February 2005.
- The Institution of Chemical Engineers [UK].
Energy at the crossroads, the chemical engineering contribution to the UK energy
debate.
The Institution of Chemical Engineers for the Energy Minister, September 2002.
- International Standards Organisation.
Equal loudness level contours, ISO 226:2003.
ISO, 2003.
- Ising H; Babisch W; Kruppa B.
Noise-induced endocrine effects and cardiovascular risk.
Noise and health 1999; 1(4): 37 – 48.
- Ising H; Braun C.
Acute and chronic endocrine effects of noise: review of the research conducted at the
Institute for Water, Soil and Air Hygiene (Berlin, Germany).
Noise and health 2000; 2(7): 7 – 24.
- Katz RV.
Personal communication, 3 February 2007.

- Keller J.
Nova Scotians flee home, blame vibrations from 17 turbines for loss of sleep, headaches.
Canadian Press <http://thestar.com> , 13 November 2006.
- Larivee R.
Letter to the County Commissioners, Meyersdale, Pennsylvania, USA.
<http://www.pbase.com/wp/image/39285457> , 2005.
- Laughton MA.
Power to the people: future-proofing the security of UK power supplies.
ASI Adam Smith Institute, London (UK), 2003,
www.adamsmith.org/policy/publications/pdf-files/powerpeople.pdf .
- LeFanu J.
In sickness and in health.
Daily Telegraph [UK], 14 March 2004.
- Leishman JG.
Challenges in modelling the unsteady aerodynamics of wind turbines.
Wind energy 2002; 5: 85 – 132.
- Leventhall G.
Infrasound from wind turbines – fact, fiction and deception.
Canadian acoustics 2006 Jun; 34(2): 29 – 36.
- Leventhall G; Pelmeur P; Benton S.
A review of published research on low frequency noise and its effects.
Report for DEFRA Department for Environment, Food, and Rural Affairs (UK), May 2003,
www.defra.gov.uk/environment/noise/research/lowfrequency/pdf/lowfreqnoise.pdf
- Lockett P.
Letter.
Plymouth, UK: Western Morning News, 15 November 2003.
- Lockett P.
Letter, personal communication.
15 November 2003.
- Lockett P and Lockett P.
Letter.
Plymouth, UK: Western Morning News, 16 October 2001.
- Lovelock J.
The revenge of Gaia: why the Earth is fighting back – and how we can still save humanity.
Allen Lane (Penguin), 2006.
- Lundberg U.
Coping with stress: neuroendocrine reactions and implications for health.
Noise and health 1999; 1(4): 67 – 74.

- Manley DMJP; Styles P.
Infrasound generated by large sources.
Proceedings of the Institute of Acoustics 1995; 17: 239 – 246.
- Manley DMJP; Styles P; Scott J.
Perceptions of the public of low frequency noise.
Journal of low frequency noise, vibration and active control 2002; 21(1): 37 – 44.
- Martin PR.
How do Trigger Factors acquire the capacity to precipitate headaches?
Behaviour research and therapy 2001; 39: 545 – 554.
- Martin PR; Reece J; Forsyth M.
Noise as a trigger for headaches: relationship between exposure and sensitivity.
Headache 2006; 46: 962 – 972.
- Martin PR; Teoh H-J.
Effects of visual stimuli and a stressor on head pain.
Headache 1999; 39: 705 – 715.
- Martin PR; Todd J; Reece J.
Effects of noise and a stressor on head pain.
Headache 2005; 45: 1353 – 1364.
- Maschke C; Hecht K.
Stress hormones and sleep-disturbances – electrophysiological and hormonal aspects.
Noise and health 2004 Jan-Mar; 6(22): 49-54.
- McKendrick AM; Badcock DR.
An analysis of the factors associated with visual field deficits measured with flickering stimuli in-between migraine.
Cephalalgia 2004; 24: 389 – 397.
- McManus S.
Turbines still causing a problem, neighbors say.
Michigan, USA: Mackinaw Journal, 29 August – 26 September 2002, p 3.
- Moller H; Andresen J.
Loudness of pure tones at low and infrasonic frequencies.
Journal of low frequency noise and vibration 1984; 3(2): 78 – 87.
- Moller H; Lydolf M.
A questionnaire survey of complaints of infrasound and low frequency noise.
Journal of low frequency noise, vibration and active control 2002; 21(2): 53 – 63.
- Morris PJ; Long LN; Brentner KS.
An aeroacoustic analysis of wind turbines.
American Institute of Aeronautics and Astronautics: AIAA-2004-1184; 42nd AIAA Aerospace Sciences Meeting, 5-8 January 2004, Reno, Nevada [USA], 2004.
- Mott M.
Did animals sense tsunami was coming?
National Geographic News 4 January 2005.

- National Audit Office [UK].
The new electricity trading arrangements in England and Wales, 9 May 2003.
Auditor General, HC624 Session 2002-2003, 11 February 2003; also NAO HC210
Session, 2004-2005.
- Navy adapts sonar to protect whales.
The Sunday Times [UK], 26 March 2006.
- Neighbors complain of wind farm nuisances.
New Mexico, USA: The Albuquerque Tribune, 28 April 2006.
- Pawlaczyk-Luszczynska M; Dudarewicz A; Waszkowska M; Sliwindska-Kowalska
M.
Assessment of annoyance from low frequency and broadband noises.
International journal of occupational medicine and environmental health 2003; 16(4):
337 – 343.
- Pawlaczyk-Luszczynska M; Dudarewicz A; Waszkowska M; Szymczak W;
Kamedula M; Sliwinska-Kowalska M.
The effect of low frequency noise on human mental performance [Polish].
Medycyna pracy 2004; 55(1): 63 – 74.
- Pawlaczyk-Luszczynska M; Dudarewicz A; Waszkowska M; Szymczak W;
Sliwinska-Kowalska M.
The impact of low frequency noise on human mental performance.
International journal of occupational medicine and environmental health 2005; 18(2):
185 – 198.
- Pedersen E.
Noise annoyance from wind turbines – a review. Report 5308.
Naturvårdsverket Swedish Environmental Protection Agency, August 2003,
www.naturvardsverket.se/bokhandeln .
- Pedersen E; Persson Waye K.
Audio-visual reactions to wind turbines.
Proceedings of Euronoise 2003; 5th European Conference on Noise Control, 19 – 21
May, 2003, Naples, Italy, 2003.
- Pedersen E; Persson Waye K.
Perception and annoyance due to wind turbine noise – a dose-response relationship.
Journal of the acoustical society of America 2004 Dec; 116(4): 3460 – 3470.
- Pedersen E; Persson Waye K; Hallberg LRM.
Living close to wind turbines – a qualitative approach to a deeper understanding.
Proceedings of Internoise2004, Prague, 2004.
- Persson Waye K; Bengtsson J; Rylander R; Hucklebridge F; Evans P; Clow A.
Low frequency noise enhances cortisol among noise sensitive subjects during work
performance.
Life sciences 2002 Jan 4; 70(7): 745 – 758.

Persson Waye K; Clow A; Edwards S; Hucklebridge F; Rylander R.
Effects of nighttime low frequency noise on the cortisol response to awakening and subjective sleep quality.
Life sciences 2003 Jan 10; 72(8): 863 – 875.

Persson Waye K; Ohrstrom E.
Psycho-acoustic characters of relevance for annoyance of wind turbine noise.
Journal of sound and vibration 2002; 250(1): 65 – 73.

Persson Waye K.
Low frequency noise pollution interferes with work performance.
Noise and health 2001 Oct-Dec; 4(13): 33 – 49.

Pierpont N.
Wind turbine syndrome: testimony before the New York State [USA] Legislature Energy Committee, March 7, 2006.

The Planning Inspectorate, Bristol.
Appeal Decision, by RD Hiscox.
Appeal ref: APP/Q0830/A/05/1189328,
Penpell Farm, Par, St Austell, Cornwall, PL24 2SA,
17 January 2007

Podoshin L; Ben-David J; Pratt H; Fradis M; Sharf B; Weller B; Wajsbort J; Zellinger M.
Auditory brainstem evoked potentials in patients with migraine.
Headache 1987 Jan; 27(1): 27 – 29.

Prasher D.
Widex Noise Report: traffic noise in England 2007.
University College London (UK) and Widex, January 2007, www.widex.co.uk.

Pratt H.
Personal communication, 14 March 2006.

Pratt H.
Personal communication, 15 March 2006.

Rasmussen F; Hartvig Hansen M; Thomsen K; Larsen TJ; Bertagnolio F; Johansen J; Aagaard Madsen H; Bak C; Melchior Hansen A.
Present status of aeroelasticity of wind turbines.
Wind energy 2003; 6(3): 213 – 228.

Renewable Energy Foundation (REF; London, UK).
Studies on wind turbine noise raise further concerns.
REF press release, 4 August 2005.

Renewable Energy Foundation (REF)
Submission to Yelland wind farm planning appeal, Devon, 2 April 2006.

Renewable Energy Foundation (REF).
UK Renewable energy data, Issue 1 (08.12.06): vol. 5: Wind.
Research conducted by Oswald Consultancy Ltd., August 2006,
www.ref.org.uk/energydata.php .

Royal Academy of Engineering.
An engineering appraisal of the PIU energy review.
Royal Academy of Engineering for the Energy Minister, August 2002.

SafetyLine Institute of WorkSafe Western Australia, Department of Consumer and
Employment Protection.
Identification of whole-body vibration: effects on health.
Government of Western Australia, 1998.

SafetyLine Institute of WorkSafe Western Australia, Department of Consumer and
Employment Protection.
Whole body vibration effects on health.
Government of Western Australia, 1998.

Schomer PD.
For purposes of environmental noise assessment, A-weighting needs to be retired.
JASA Journal of the acoustical society of America 2002 Nov; 112(5, pt 2): 2412.

Sezer-Uzol N; Long LN.
3-D time-accurate CFD simulations of wind turbine rotor flow fields.
[CFD: computational fluid dynamics]
American Institute of Aeronautics and Astronautics: AIAA Paper No. 2006-0394,
2006.

Shepherd KP; Hubbard HH.
Physical characteristics and perception of low frequency noise from wind turbines.
Noise control engineering journal 1991 Jan/Feb; 36(1): 5 – 15.

Shultz T.
Community noise rating, 2nd ed.
Applied Science Publishers, 1982.

Simpson D.
Tilting at windmills: the economics of wind power.
David Hume Institute, no.65, April 2004.

Small Business Council [UK]
UK energy policy: the small business perspective and the impact on the rural
economy. Report prepared by C Whitmill.
Small Business Council, February 2006.

Spreng M.
Central nervous system activation by noise.
Noise and health 2000; 2(7): 49 – 58.

Spreng M.
Noise induced nocturnal cortisol secretion and tolerable overhead flights.
Noise and health 2004 Jan-Mar; 6(22): 35 – 47.

Spreng M.
Possible health effects of noise induced cortisol increase.
Noise and health 2000; 2(7): 59 – 64.

Stephens DG; Shepherd KP; Hubbard HH; Grosveld F.
Guide to the evaluation of human exposure to noise from large wind turbines.
NASA National Aeronautics and Space Administration, Langley Research Center,
Hampton, Virginia (USA), NASA-TM-83288, March 1, 1982.

Stewart J.
Location, location, location.
UKNA United Kingdom Noise Association, August 2006.

Stop Cambridge Wind Farm (UK)
www.stopcambridgewindfarm.org.uk/pages/deeping_st_nicholas.htm
News item about Jane Davis and wind turbine noise issues at Deeping St Nicholas.
2006.

“Stop lying about these turbines.” (Kelly Alexander)
Michigan, USA: Holland Sentinel, 31 December 2002.

Styles P.
Summary report to Defence Estates.
Keele University (UK), Report for the Ministry of Defence, 3 March 2004.

Styles P; Manley DMJP.
Low frequency noise and vibration levels at a modern wind farm.
Funded by ETSU on behalf of the Dti, 1996.

Styles P; Stimpson I; Toon S; England R; Wright M.
Microseismic and infrasound monitoring of low frequency noise and vibrations from
windfarms: recommendations on the siting of windfarms in the vicinity of
Eskdalemuir, Scotland.
Keele University (UK), Report for the Ministry of Defence, 18 July 2005.

Takahashi Y; Yonekawa Y; Kanada K; Maeda S.
A pilot study on the human body vibrations induced by low frequency noise.
Industrial health 1999 Jan; 37(1): 28 – 35.

Tasker J.
‘Wind farm noise is driving us out of our house.’
Hunt is on for the source of the elusive ‘Whoosh’.
Farmers weekly 12 January 2007.

Turitea man fears he’ll have to go.
<http://stuff.co.nz> , 10 November 2006.

United States Department of Defense.
The effect of windmill farms on military readiness. Report to the Congressional
Defense Committees.
Office of the Director of Defense Research and Engineering, US Department of
Defense, 2006.

van den Berg GP.
The beat is getting stronger: the effect of atmospheric stability on low frequency modulated sound of wind turbines.
Journal of low frequency noise, vibration, and active control 2005 Mar; 24: 1 – 24.

van den Berg GP.
Effects of the wind profile at night on wind turbine sound.
Journal of sound and vibration 2004; 277(4-5): 955 – 970.

van den Berg GP.
Do wind turbines produce significant low frequency sound levels?
11th International Meeting on Low frequency noise and vibration and its control, Maastricht, The Netherlands, 30 August – 1 September 2004.

Vanagaite Vingen J; Pareja JA; Støren O; White LR; Stovner LJ.
Phonophobia in migraine.
Cephalalgia 1998; 18: 243 – 249.

Whittle LS; Collins SJ; Robinson DW.
The audibility of low frequency sounds.
Journal of sound and vibration 1972; 21: 431 – 448.

Wolach I; Pratt H.
The mode of short-term memory encoding as indicated by event-related potentials in a memory scanning task with distractions.
Clinical neurophysiology 2001 Jan; 112(1): 186 – 197.

World Health Organisation.
Occupational and community noise. Fact sheet no. 258.
Geneva: WHO, February 2001.

World Health Organisation.
Guidelines for community noise.
Geneva: WHO, 1999.

Wust S; Wolf J; Hellhammer DH; Federenko I; Schommer N; Kirschbaum C.
The cortisol awakening response – normal values and confounds.
Noise and health 2000; 2(7): 79 – 88.

Young N.
Wind power debate blows near and far.
Western Morning News, 23 January 2004

APPENDIX – PROPERTY VALUES

1. INTRODUCTION

This Appendix provides global evidence of the negative impact of wind farms on residential property values where the wind turbines are built nearby.

The valuation of a residential property is what it will fetch in an open market sale. The value will depend upon a number of factors and not least will be the number of potential buyers in the market for that type of property in that location. More than one buyer is likely to trigger a bidding-up situation. Wind farms are normally built in rural locations, therefore apart from accommodation size, important influences on value will often be the view, the peace and serenity, and a rural environment.

It is established that in many rural locations a wind farm will reduce the value of properties located nearby; but as the distance between wind turbines and dwellings increases, the valuation impact is lessened and the prospect of consequent health problems reduced. A part of the loss in value will be attributable to the loss of a quality view. However, a substantial apportionment of the loss in value flows directly from the environmental noise pollution and indeed the consequent health impact that flows directly from the environmental noise pollution. A further smaller part of the loss will be attributable to the rotation of the turbine blades, which in certain circumstances will cause strobing light/shadow flicker, which again can have health repercussions. In a high value area of the country, the potential valuation impact is likely to be higher.

It is important to establish the part of the valuation loss that directly flows from the environmental noise pollution as this, in most instances, will reflect the property damage resulting from the escape of the noise pollution. In a well-populated rural area the cumulative financial damage, the loss imposed on the community, will substantially exceed the ‘de minimus’ public interest that will be served from the wind farm. The following are samples of reported property devaluations from three continents.

2. U.K.

Case A

TURBINE PLAN CUT VALUE OF OUR HOME BY A THIRD Western Morning News (Plymouth) 9 December 2004

“A Westcountry farming couple have seen the value of their home slashed by a third since controversial plans were submitted to build three giant wind turbines in one of the region's beauty spots, it has been revealed.

Richard and Lynne Lethbridge say they discovered the devastating news after deciding to sell the home their family has farmed from for decades, because of the plans for the turbines.

Two independent agricultural valuers, which visited the large four bedroom bungalow in East Allington last week, both concluded that since the planning application for the turbines at Goveton was submitted earlier this year, the price of the Lethbridge's near £500,000 home had fallen by £165,000.

NPower's plans, which have been submitted to South Hams District Council, are for three generators, each 100 metres high, to be built on land off the A381 between Kingsbridge and Totnes, next to the turning for Goveton.

Mrs Lethbridge, 57, whose property is the closest to the proposals at just 540 metres away from the development, said she had envisioned living in the area with her husband Richard, 58, for the rest of their lives. But she said that it looked extremely likely they would have to move on. "If the plans go through we will have to sell," she said.

"We're upset because it's detrimental to our health and we are so close that we would hear them and to me it would also be a great eyesore. We decided to have the house valued with a view to selling because we're concerned about our livelihood. Richard is a farmer and has been all his life and for the last 15 years or so I've been a farmer's wife. His parents have been here for over 60 years and he was born here and built the home we are in at the moment on the same land in the early 1970s. I thought we would live here all of our lives and this would then go to our family. We would not have thought of moving but we feel we are being forced out because of this. Mrs Lethbridge said the only way the family would consider staying at their home would be if the plans did not go ahead.

"When we found out about the application we realised it was just 540 metres away. It's too close to us. If the plans go ahead we will move. I don't think anyone could change our minds, which is really sad. Her husband Richard added: "I don't really want to leave here, but the noise will be a big problem and with the health issues and the loss of view it will be too much. It doesn't matter how much compensation we would get, if any, because it would be the view and the way of life we would lose."

Case B

In a survey of its members in November 2004, **The Royal Institution of Chartered Surveyors** issued 1942 questionnaires and received 405 responses, of which 20% (81) had dealt with transactions affected by wind farms. The Report stated:

"Actual effect:

*-- there are negative influences on the values of residential properties, though a sizeable minority report no impact on prices.
-- nowhere is it considered that wind farms positively affect residential property values"*

"The regional results vary from 44% of surveyors in Wales reporting that residential property values are lower as a result of wind farm developments to a high of 77% in the South West."

“Conclusions:

The three main reasons for this negative impact on property values are the visual impact after completion, the fear of blight and the proximity of residential property to a wind farm development”

The negative impact of wind farms on property values appears to decline over time. This may suggest that the impact lessens as wind farms become more established.”

The last conclusion appears tentative and there is no evidence in the report to support this view.

Once the zone of pollution falls in value its lower relative position to other nearby similar but unaffected properties becomes established. From this new relationship of property values, the market residential property inflation will apply to the polluted zone, but in some locations, it may be argued that the pollution is sufficiently severe that a lower inflation level will apply.

A simple example:

Consider similar properties, one in village A valued at £460,000 and a second in village B valued at £460,000. A wind farm is built close to the property in village A decreasing the price the property would fetch in a sale to £280,000. The property in village B is unaffected. After 5 years of 6% compound property inflation, the village A property will rise in value to £374,700 but the house in village B will have risen in value to £615,580, a loss to the house in village A of £240,880.

Some might argue that the rise in value of the house in village A represents a recovery from the initial impact of the wind farm. Others will contend the damage in terms of financial loss remains with the property.

Case C

WINDFARM BLOWS HOUSE VALUE AWAY

Westmorland Gazette, 9 January 2004

“Barry Moon and his partner, Gill Haythornthwaite, live in the shadow of the wind turbines at the controversial Ireleth windfarm near Askam. When they bought Poaka Beck House in 1997, the couple were unaware the arrival of the windfarm was imminent. Previous owners, David and Diane Holding failed to tell the prospective buyers in spite of the fact that they had vigorously opposed the initial application for the wind farm in 1995.

District Judge Buckley decided that this amounted to material misrepresentation and ordered the Holdings to pay compensation of 20% of the market value of the house in 1997, £12,500 plus interest, because of damage to visual amenity, noise pollution, and the ‘irritating flickering’ caused by the sun going down behind the moving blades of the turbines 550 metres from the house.”

Case D

In a letter to a client about the effect of wind turbines on property values, dated May 1998, Estate Agent **FPD Savills** [Norfolk Office] concluded:

"Generally, the higher the value of the property the greater the blight will be... As you go up the value scale, buyers become more discerning and the value of a farmhouse may be affected by as much as 30 per cent if it is in close proximity to the wind turbine."

Case E

PRICES FALLING

Lynwen Evans, Cambridge News, 11 April 2005

"I would like to put my statement to you loud and clear in response to your article "properties not hit by wind farm" (News, April 5).

I for one am in the same position as lots of people in the UK at this moment with the wind farm growing in popularity.

The first thing I did when the news got out about the proposed wind farm, was invite an estate agent to value my property. You can imagine my response when I was told that the value of my "basic three-bedroom bungalow" was going to drop £45,000.

With that, I had a discussion with one of the farmers involved in this wind farm, and she herself told me that they have had their property valued, and yes, it will lose value, but of course the land will gain value because of the wind farm.

One of the villagers put their property on the market as soon as the news came out. They had three people interested, until they were told there was a proposed wind farm. At that, they all pulled out.

These estate agents don't like admitting that there is a fall in property values. Needless to say, they themselves will be out of pocket.

Two of the villagers went into an estate agent asking about the prospects of selling properties in the villages concerned, only to be told that "these areas are now a no-go area!"

It's time devaluation is made known, everyone should know of what's going to happen to all that they have worked for.

Lampeter

Ceredigion

Wales

<http://www.cambridge-news.co.uk/news/letters/2005/04/11/529e6c57-a1ec-428b-ad0c-855515b543cc.lpf>

Case F

In a letter to the ***Brecon and Radnor Express and Powys County Times***, 27 July 1995, Mrs Moores of Bucks wrote:

“My mother lives in Wales within sight of a wind factory. For two years we have been trying to sell her house as she is old and frail and wishes to buy a place near us in Bucks ... So be warned – it seems that once a wind factory is built within sight of your home , the value drops considerably. We have been forced to drop nearly to half the original price and have still not sold.”

Case G

The Managing Director of Bradleys, (Chartered Surveyors), wrote the following letter in November 2004, to the Denbrook Valley Action Group, which is opposing wind turbines in Mid Devon.

“Dear Sirs

Thank you for your e.mail dated 3rd November 2004, with respect to a proposal to develop a site of 10 or more (approximate) 300-400 foot wind turbines in the Denbrook Valley between Spreyton, Bow and North Tawton.

You have requested that I comment on various matters with respect to this proposed development.

There is no doubt that no added value would be brought to a property sited within the locality of such a development.

It is likely that properties sited within the locality of such a development will be devalued , although the amount of devaluation will depend heavily on not just the proximity but also on individual matters affecting the uniqueness of each property such as spoiling the view or being affected by noise pollution. If, for example, a wind turbine is only 300 metres away from a property it may be in such a position that it cannot be heard or seen. But another property, say 800 metres away could be in full view of the turbine and also subject to its noise pollution.

Under certain circumstances it would be possible for a property within 600 - 800 metres to be devalued by some 30%, property within 1 mile possibly 20% and property within 2 miles possibly 10%. It is important to stress that each individual property would be affected in a different way.

Although it is conceivable that a property within 600/800 metres of such a development would be un-saleable there is no doubt that the property could be significantly devalued, and no doubt its marketability adversely affected.

It should be taken into account that the area in question is one of high desirability and high value and one of the most important reasons for this is its beautiful mid Devon countryside location. Therefore the area around the proposed development would be significantly affected.

With regard to the two comments that “there is no evidence of a general devaluation of local property prices caused by a wind farm”, and “the lack of

a house price affect is also confirmed by the Royal Institution of Chartered Surveyors who state that there are no studies that suggest an affect either way”, these comments are not actually saying that property prices are not being devalued, they are only stating that there are no studies which have been carried out with regard to the price affect.

I would also point out that any Chartered Surveyor carrying out a valuation on a property in the West Country, where in the proximity there are features such as electricity pylons, radio masts and wind turbines, then there will be a comment in that report that it could affect value, marketability, and/or resaleability.

Yours sincerely

BRADLEYS SURVEYORS

Case H

In a letter of 22 October 2003, South West Estate Agent J Carslake of **Kivells Estate Agents**, Holsworthy, wrote to a client advising:

“It is the case that a wind turbine within sight or sound of a residential property will affect the value of the property detrimentally. The affect on value would, in my opinion, be up to 50% of ordinary open market value, but it is difficult to provide proof of this.”

“It is certainly also the case that the threat of a windfarm close to a property can make it un-saleable (I have a case in Bradworthy for example) and would certainly assert that the marketing becomes much more problematic when a wind turbine is situated within sight or sound.”

Case I

Evidence of reduced house prices as a direct result of the threat and/or presence of wind turbines can be found on the website of the **Mynydd Llansadwrn Action Group (Wales)** [<http://www.turbineaction.co.uk/wind-turbine-facts.htm#refs>]

“In May 2005, a local resident near Brechfa reported in the Carmarthen Journal that:

"Our property, in the middle of the proposed TAN8 site (Strategic Area G) had a firm offer of £318,000. One week later our prospective purchaser, who incidentally knew about the turbines and had no problem with them, said they would do us a favour and 'take it off our hands at a big financial risk - for a reduced £250,000 which was higher than the 40 per cent we could expect to get, being near turbines!' ”

Case J

Surveyor and Valuer Gareth Scourfield inspected a number of properties in July 2005 near a proposed development of 10 wind turbines at Esgairwen Fawr, Lampeter Wales.

In his report entitled '*Report on a sample of properties inspected near a proposed wind farm at Esgairwen Fawr, near Lampeter, Ceredigion*' (July 11, 2005), he wrote:

"The proposed development also towers over houses in Mydroilyn village. Given a sample of properties inspected and reported as above [i.e., in his Report] this represents an immediate loss of £1,528,000 for the 8 properties mentioned, let alone all those which may be affected by the turbines, both by seeing them and hearing them."

Case K

Giant blades are slicing prices

Sunday Telegraph, 17th October 2004, House and Home supplement, page 2

[Excerpts from article by Ross Clark]

Homeowners on the damp expanses of Romney Marsh in Kent have long had to contend with the presence of Dungeness nuclear power station, asking themselves what would happen if it blew its top. Rather less might they have suspected that they would one day find themselves cursing the nuisance posed by "green" renewable energy. Last week, the DTI began an inquiry into plans for a wind farm whose 27 turbines will spread over 1,000 acres of the marsh and stretch into the sky 370ft.

Much of the recent debate over wind farms has revolved around whether they lower the value of nearby properties. Until earlier this year, the British Wind Energy Association (BWEA) maintained that wind farms do not affect values - in fact, the association listed this as one of the "top 10 myths about wind farms" on its website.

In January, however, came the case of Barry Moon, who won £15,000 in damages against the previous owners of his four-bedroom home at Marton, near Ulverston, Cumbria. The vendors had failed to warn Moon about plans for a wind farm on a nearby hill. After hearing evidence from chartered surveyors, the judge made an award on the basis of a 20 per cent reduction in value of Moon's home due to the visual impact of the turbines and the annoying, low-frequency hum. "I've lived a similar distance from the M3 as we live from the wind turbines," says Moon, "but this was a lot worse. What is irritating is the way the whooshing keeps increasing and decreasing in magnitude."

While the Moon case established in law for the first time that a wind farm can lower the value of a home, it did nothing to help homeowners win compensation from the builders and operators of wind farms.

What residents can do is ask the environmental health officer at their local authority to measure the sound produced by the turbines and declare a statutory noise nuisance. As a result of measurements taken by Barrow District Council, Moon managed to persuade Powergen, the operator of the wind farm,

to install a noise management system, which shuts down three of the turbines when the wind is coming from a certain direction.

Three other couples, who live within half a mile of the turbines, had a less happy experience. In January, they took Powergen to Kendal Magistrates Court to win a noise abatement order - and lost. "We were told that our evidence lacked specificity, even though we had 26 recorded cases of noise nuisance," says David Brierley, a former policeman who wasn't named in the case, but who helped the residents compile their evidence.

"The noise management system doesn't work. I live 1,000m south of the wind farm and my wife, who is asthmatic, gets very distressed when the wind is coming from the north because she can feel her breathing trying to synchronise with the thump of the blades."

If the experience of Cumbrian homeowners is anything to go by residents within a mile or so of the proposed Romney Marsh wind farm will have an uphill struggle selling their properties from now on.

Kyle Blue, a Penrith estate agent, runs a protest group objecting to a proposed 27-turbine wind farm at Whinash, Cumbria. In May, the Advertising Standards Authority (ASA) upheld a complaint against him by the BWEA for claiming, on the group's website, that the wind farm would affect property values (the ASA indicated it would have been happy with might affect property values).

Yet when his company auctioned Bretherdale Hall, a semi-derelict farmhouse half a mile from the proposed turbines; it fetched £200,000 - £80,000 less than its valuation before the plans for wind farms were announced.

Another nearby property, a freshly restored £340,000 farmhouse, found a buyer who said the wind farm wouldn't bother him because he was keen on renewable energy. "Then, he went away, did some research and changed his mind," says Blue. The house remains unsold.

Case L

In May 2000, Estate Agents Russell Baldwin & Bright, Brecon in Powys, wrote the following to letter a client:

"Further to our telephone conversation last week I confirm that I have withdrawn your property from the market.

As discussed since the proposed Wind farm planning application was published enquiries for your property have fallen off dramatically. It is obviously very disappointing that this situation has arisen after such a promising response to earlier marketing which resulted in an excellent number of viewings. There is however, little point in continuing to market your property as any serious purchaser will be immediately put off by the prospect of a nearby windfarm.

On a more general note I have a prospective purchaser at Merthyr Cynog having serious doubts over its proximity to the proposed site.

I will keep the file pending until planning application is resolved at which time I trust we will be able to re-market the property."

3. AUSTRALIA

Case A

HOUSE VALUES DECLINE WITH TURBINES CLOUDS GATHERING OVER WIND FARM PLAN

The Australian, January 9, 2006, by Natasha Robinson

The picturesque fields of Foster North, in Victoria's South Gippsland, have become a battleground with farmers and residents divided over a proposal to build a massive wind farm. Farmers who will benefit from the 125m turbines being built on their land are pitted against their neighbours who bitterly oppose the 48-turbine, 2000-hectare Dollar Wind Farm project. And as state governments grapple with energy demands amid a looming coal crisis, it is a fight likely to be played out in communities around the country.

Victoria's Government had "ridden roughshod" over the Foster North and Dollar communities in refusing to give their council a say on whether the proposal went ahead, Federal Environment Minister Ian Campbell said yesterday. The Victorian Government made its decision before Christmas on the project, planned for the northern side of the South Gippsland Highway at Foster North and Dollar. It is yet to publicly announce if it approved the wind farm. Premier Steve Bracks has pledged to source 10 per cent of the state's energy from renewable sources by 2010. The Dollar Wind Farm project was previously the work of a New Zealand-owned company but the project was sold last year to Australian company AGL. The proposal is now with Senator Campbell, who will consider if it poses national environmental concerns.

In Frank and Theresa Cicero's quiet, winding, street in Foster North, local opposition to the wind farm -- which will see a turbine built 800m from their bush retreat -- is easy to find. Almost every property in their street, apart from those of the farmers on whose land the turbines are being built, is for sale.

'I've watched my husband work all his life to build this home," Mrs Cicero said. "We've never had loans, we've always worked and saved. And now we find everything that we've put in here, it's all worth nothing.'

The Ciceros had their home valued at \$410,000 before the wind farm was taken into account. Afterwards, the estimated value dropped to \$270,000. They have not received one offer for their property in two years. They say if the turbines are erected, they will have to cope with an incessant sun flicker, noise, and a viewing platform.

A spokeswoman for the Victorian Government said it was a complex issue and the Government understood that the community had concerns.

Web link: <http://www.theaustralian.news.com.au/common/story>

Case B

In ‘**Research of property devaluations**’, the author, Eleanor Tillinghast (Green Berkshires, Inc, Massachusetts, 2004), reports:

“In a vacation area near the Toora wind power plant in South Gippsland, Australia, a real estate agent told a news reporter that the 12 turbines were ‘definitely’ having an impact on values. ‘If they are near the property, buyers are staying away,’ Wesfarmers Landmark Leongatha agent Glen Wright said. ‘If I had to put a figure on it, I would say (a reduction of) 25 to 30 per cent on the going value.’

Another real estate sales manager had major difficulties selling a property near the Toora plant. ‘I would have shown 50 or 60 people through that property and I would say half of those wouldn’t even look at the place once they realize it’s in the vicinity of wind turbines,’ Bruce Falk said. ‘And half of the other 50 per cent were concerned about resale so they offered 20 per cent less than the price the owners would accept’

In another part of southwest Australia, John Denham, who had leased his farm for eight turbines, found that their presence hindered his efforts to find a buyer when ill health forced him to sell the land.”

4. Denmark

In Denmark, Erwin Thorius, president of the National Association of Neighbours to Wind Turbines, said recently that ‘*people living near windmills found it impossible to sell their homes*’.

A study in Denmark about 10 years ago found that housing prices decreased near wind power plants, ranging from about US \$2,900 at that time for a one-turbine facility to US \$16,800 for a 12-turbine site. [Tillinghast, 2004]

5. Germany

Case A

The Darmstadt Manifesto (1 Sept. 1998), signed by more than 100 university professors in Germany, states:

“Falling property values reflect the perceived deterioration in quality of life – not just in areas close to the turbines, but even all over Schleswig-Holstein. More and more people are describing their lives as unbearable when they are directly exposed to the acoustic and optical effects of wind farms. There are reports of people being signed off sick and unfit for work ...”

Case B

FIGHT AGAINST WIND POWER

Olympic and World Champions have got together: they demand that Wind Power Stations be Built Away from Riding Stables

“Riders, friends of the riding community and owners of equestrian and breeding businesses are anxiously watching the encroachment of wind power installations over the landscape both in the Lander and throughout the country as a whole - chief among them Judith and Klaus Balkenhol. They want to prevent wind power stations from creeping even closer to riding stables. The signatories of the Memorandum are particularly concerned that equestrian businesses which will be affected are not consulted during the application process. The construction of wind power stations close to such establishments puts into jeopardy the livelihoods of numerous businesses and endangers many jobs. Constructions in the open countryside threaten not only trekking but also recreational riding. Noise and flicker from the turbines do considerable harm to horse and rider and endanger them equally. It is not for nothing that a statutory separation was made compulsory over 200 years ago between windmills and open roads, otherwise the horse shies (“spooks”). The effect of breeding means that there is now a considerably greater number of highly sensitive horses.” (Quote from the Memorandum).

The riding community demand a separation of 2,500 - 3,000 metres [2.5 - 3.0 kilometres] between horses and windfarms.

All sensible people are in favour of alternative energy. But when these wind mills – which may be environmentally but not visually friendly – shoot out of the ground like mushrooms right before your very door, then it is quite a different matter. They are particularly unloved by horse people because the noise the blades make at various times and at various volumes, drives the horses wild, at least in the case of sensitive types such as dressage horses. Klaus Balkenhol, former Federal (German) trainer and now a national US team trainer, has himself now experienced this. The wind turbine which is 1 km away from his stables at Rosendahl in Munsterland often irritates the horses he is training to such an extent that any sensible work, to say nothing of hacking in the vicinity of the turbine, is out of the question.

A further 6 turbines are now being planned – something that Balkenhol discovered only by accident. “The Americans are not willing to train under these conditions,” Balkenhol’s wife, Judith said. “The (US National) team has made that clear to us.

The equestrian establishment, which lies in the shadow of the wind mills, is up for sale, “only at half the price, at the most, of what we invested in it.”

A petition signed by numerous top German riders and 17 thoroughbred studs is expected to draw the attention of the authorities to the dangers and damage caused to riding establishments by wind installations. Not only competition riders but recreational riders as well, find little joy in riding beneath the whirlwind. “And all the time Munsterland advertises its ideal conditions for riders,” said Judith Balkenhol.

6. New Zealand

TURITEA MAN FEARS HE'LL HAVE TO GO

The Daily News Watch, New Zealand, by Helen Harvey, November 10, 2006

A Turitea man says he will be forced from his home because Mighty River Power told him noise from wind turbines in the reserve will make his house uninhabitable.

Mark Nicholls has been living in his slice of paradise for 10 years. He has 20 hectares of native bush, 13ha of pasture, which he farms, and a view to die for. It is so private that he can bathe on his veranda.

He doesn't want to move, he said. "It's hard to achieve what I have here on my budget."

He first heard the news 12 months ago that four wind turbines from the proposed Mighty River Power/Palmerston North City Council wind farm would be 500m from his boundary.

The state-owned power company's representatives told him the noise from the turbines would make his house uninhabitable, he said.

In city council documents on the wind farm, it said that at 500m from a turbine, the accepted standard of noise should be between 40 and 50 decibels.

The report, presented at the infrastructural well-being committee on October 18, said 40 decibels is equivalent to that of a public library and a loud radio would be 70 decibels. An Ashhurst family had to leave their house last year because noise and vibration from the Te Apiti wind farm made it impossible for them to stay.

Mr Nicholls said his life has been on hold for a year and he is angry that an SOE (Mighty River) and a city council (he lives in the Tararua district) can destroy his idyllic rural paradise.

"Mighty River Power has made a lot of noise that in the fullness of time they will discuss a relocation package. This has been going on for 12 months."

He has asked the energy company what is happening, because he wants to get on with his life. "(They say) talks will take place in due course when the final location of the turbines has been established," he said.

"When you are told you can't live in your property, it changes your life. It's being told your life is going to change, but there is no qualification, no time frame. I don't know where I'm going to be in six months' time, one year's time. I can't plan. I feel that it's frustrating that one's life can be put on hold, not just mine, but my family's as well."

7. U.S.A.

Case A

Potential lessors get warning letters about turbine plan

Several residents oppose wind project in Cherry Valley
by Tom Grace Cooperstown News Bureau [New York, USA] 03/30/05

The attorney for residents opposed to wind turbines in Cherry Valley has sent warning letters to those who might lease their land for the project. The letters are intended to dissuade prospective lessors from participating in the project, said the writer, lawyer Peter Henner of Clarksville.

In the event the project, under consideration by Reunion Power of Montvale, N.J., goes forward, lawsuits may be filed. Henner said Tuesday that his clients want to be in the position of having warned their neighbors in advance.

Among the recipients of a letter from Henner is Daniel Wightman of Portlandville. His property east of the village of Cherry Valley is under active consideration by Reunion.

In a letter dated March 23 and provided to The Daily Star, Henner wrote to Wightman:

"I represent Raymond J. and Susan C. Rivard, Andrew and Kathleen Minnig, Linda VanSchaick, Philip and Leila Durkin, Patrick Shearer, Lynae Quimby, Steven and Angela Witham, Mark and Eliza Oursler, Diana Wells, Roy J. Hall and Paul Petersen, who own property that is in close proximity to your property in the town of Cherry Valley."

"It is my understanding that you are considering leasing a portion of your land to be used for the construction of wind turbines. Because these turbines may have an adverse impact upon my clients, I am writing to you to warn you that my clients will hold you responsible for any damage to their property that may result from these wind turbines."

Henner wrote that the windmills might cause his clients' property to depreciate, in which case, they "may have little choice but to commence an action to recover for the diminution in value of their property. They may also hold you liable for any adverse impacts, including the diminution of the quality of life that may result from the wind turbines."

Even if the windmills are built out of sight of his clients' homes, they may sustain a loss if the turbines can be heard from their residences, Henner said."

<http://www.thedailystar.com/news/stories/2005/03/30/win5.html>

Case B

Wind farm opponents speak out More testimony set for tonight

By Mike Johnston, Kittitas Valley News [Washington, USA]
12 January 2006

Opponents of the Kittitas Valley Wind Power Project dominated Wednesday's second hearing on the wind farm proposed for 12 miles northwest of Ellensburg. They said the damage to scenic views from the wind turbines can't be lessened and will reduce property values.

Horizon has applied for up to 80 turbines ranging in height from 250 to 410 feet high, but company officials say they will only build 64.

The Desert Claim project, proposed by EnXco USA Inc. and centered eight miles north of Ellensburg, planned 120 turbines.

Slothower said those factors include conflicts with an increasing number of rural residences being built nearby and the subdivision of land for future homes and recreation, damage to the scenic views and others.

Colleen Anderson of Peavine Road, a real estate agent with Coldwell Banker-Kittitas Valley Realty, said she has compared average land sales near the wind farm with overall average county land sales involving parcels ranging from three to 20 acres. The sales took place in the last six months.

Anderson said land sales near the project area averaged \$66,038, but the average countywide sale price was \$126,223, a difference of \$60,185. She also said lands for sale near the project area linger on the market longer.

'Based on this information,' Anderson said, 'it is my professional opinion that real estate values are adversely affected by the wind farms.'

She called on the two commissions to deny the project.

<http://www.kvnews.com/articles/2006/01/12/news/news02.txt>

Case C

The Wayward Wind

by Jon Boone, Silver Lake, New York, USA, 19 June 2006

"Do you believe industrial facilities stretching many miles across your landscape, with 105 spinning sky-scraper sized structures creating a cascade of noise are not going to negatively affect property values for those in the neighborhood, as the wind industry maintains a government study proves? One of the most validated real estate precepts is that prominent natural views and historic scenery have premium value, and intrusions restricting those views erode value ...

There are few windplants in the world, let alone the United States, with turbines over 400 feet tall placed so prominently near a resort community ...

Independent inquiry in Britain, Denmark, and New England suggest the likelihood of significant property devaluations. In his June 10, 2005 direct testimony before the Wisconsin Public Service Commission, Kevin Zarem, an appraiser, estimated that residential property near a proposed windplant “will likely be in the 17% -- 20% loss range.” And this is based solely upon visual impact. He did not assess potential loss due to wind turbine noise, motion, or shadows.

Russell Bounds, one of Garrett County’s leading realtors in large property transactions ... has already lost sales in the area of proposed windplants. Mr. Bounds testified in a PSC hearing that, over the last several years, he has had at least 25 people who expressed interest in buying land in the area targeted by wind developers. However, when he advised them about the plans for wind facilities, not one of those people expressed further interest.”

... I have seen contracts which require land owners and encourage neighbors to sign a “memorandum of non-disturbance easement agreement,” which absolves the wind company from liability for what the owners might regard as wind turbine-related nuisances.”

Case D

Hearing for a proposed wind turbine development in Maryland, in 2006,

The panel heard the testimony of Russell Bounds, Railey Realty, McHenry, Garrett County, Maryland, a licensed estate agent and property appraiser.

The following is taken from his recorded testimony at the hearing.

‘In 2004, Mr Bounds’ sales totaled more than \$15,000,000; his volume of sales has averaged about \$12,000,000 per year. His work in Garrett County covers mountain or acreage properties in a place of natural beauty. In his testimony, Mr Bounds was asked if had visited areas where wind turbines are in place:

“Yes. I have been to sites in nearby Pennsylvania, experienced the visual impact near the turbines and heard the noise impact from various distances ... I do not know the markets in West Virginia or Pennsylvania very well. If we were to move those turbines to Garrett County, however, value would be impacted. Any time you take a thing of natural beauty and you insert industrial development there is an adverse impact on what the property offers. It not only devalues but quite frankly, from my experience in Garrett County anyway, it may render the property unsaleable.”

Mr Bounds had viewed properties with the turbines at a distance of three miles to “very close by.” Asked “What effect, if any, has the wind turbines had on the special characteristics of properties that are nearby the wind turbines?”, Mr Bounds responded:

“Within the view shed it ruins the horizon. The closer you get to the turbines the greater the visual impact. Those people who are looking for the natural views of the mountains find they are diminished or no longer exist. The turbines not

only have a visual impact but, also impact the quality of life. The ones that I visited were very noisy. They impact a country setting with a rather large industrial wind plant that takes away from anything I would call heritage views, peace and quiet.”

Mr Bounds answered “Yes,” when he was asked if he had heard from people living near wind turbines and if they had told him about any problems:

“The primary complaint is noise. Second is the visual impact of the turbines. Going into the house and closing the door eliminates the view. It does not eliminate the sound. The constant drone cannot be escaped ... Their greatest concern is the substantial loss of value of their property. They do not believe they can sell without substantial loss and cannot afford to sustain the loss and move.”

When asked if the noise had any substantial impact on the use of the property, Mr Bounds replied:

“Yes. It takes away the enjoyment of their property. It doesn’t allow them to sleep at night.”

“It takes a property of substantial value and takes away all of the characteristics that are the strengths of that property. The visual impact takes away value. The noise takes away value. The property owners complain that the wind turbines take away value and there is no way for them to escape.”

Mr Bounds testified that he knew of property transactions in Somerset, Pennsylvania that were sold for substantially less than their prior sale price because of the proximity and impact of wind turbines. Mr Bounds continued,

“Two properties specifically that sold for substantially less than their original purchase price because of the nuisance issues that were created by wind turbines. The parcels adjoin property with wind turbines. (The deeds of the properties were presented as exhibits.) Somerset Windpower, LLC purchased the property of David Ray Sass for \$104,447.50 and sold it to Jeffrey A. Ream for \$65,000 ... Keith and Billie Sarver sold their property to Somerset Windpower LLC for \$101,049.00. Shortly thereafter it sold for only \$20,000.”

‘Another property -- unimproved, was purchased for \$12,600 only a few years earlier, The house was five years old when sold for \$67,000, at about the same time as the other houses were sold. Mr Bounds noted that, “the property appears to have been sold for less than market value of the same home not located in proximity to the wind turbines. The wind turbines clearly had an adverse impact on the value of nearby properties.”

Mr Bounds also replied that he had heard the wind turbine noise himself:

“It was not what I expected. When you are right underneath, it doesn’t seem to make much noise, just a swish. Further away from the structure the noise is more noticeable. It seems that it can echo through a hollow or a valley. Sometimes homes that are closer might not have the same noise impact as homes that are further out. I understand the noise changes day to day depending upon which way the wind is blowing and how the blades are

positioned. Some days it may be noisier than others and some days it might not be as noisy.”

With his research and professional expertise, Mr Bounds concluded:

“That property values of the natural and scenic properties within one-half mile and probably within a mile of the wind turbines will be negatively impacted. I cannot judge for certain how far the serious negative impact will extend. The visual impact and the noise impact will substantially diminish special attributes of a mountain view, scenic view, natural setting and peace and quiet. Undeveloped properties will be rendered un-developable. Some parcels may be rendered un-saleable. The visual impact beyond a mile will likely adversely impact value. The sound impact will apparently vary outside one mile but, if the results of the study attached as Exhibit 9 are correct, the value of some properties outside one mile will be adversely impacted by the noise.”

Case E

In Michigan, David Maturen, a real estate appraiser and Kalamazoo (Michigan) County Commission, wrote the following letter to the Michigan Wind Working Group, 9 September 2004:

MATUREN & ASSOCIATES, INC.
Real Estate Appraisers – Consultants
1125 E. Milham Avenue
Portage, Michigan 49002
269-342-4800

DT: September 9, 2004

TO: Michigan Wind Working Group
c/o John Sarver, Energy Office

RE: Impact of Wind Turbine Generators on Property Values

First of all I wish to thank you for including me in your email distribution list relative to the proceedings of the Wind Working Group. I have an interest in the topic as a Kalamazoo County Commissioner concerned with land use and regulation and as real estate appraiser interested in the issue of external obsolescence (loss or depreciation to property value from outside the property boundary). That economic obsolescence can come from adverse (nuisance) impacts such as visual (loss of viewshed), blade flicker (strobe effect), noise, ice throw from blades in winter, and other environmental impacts from ancillary installations. I am not aware of any plans to put a wind farm in the vicinity of any property that I own, so I have no personal interest one way or the other in this matter, other than wanting the rights all parties to be respected and protected.

I understand that you have as an item of discussion at your September 9, 2004 meeting the issue of property values. I have had some experience with research on this matter. Unfortunately, I have a prior commitment that day and will likely not be able to attend your meeting. Perhaps your committee is already aware of these valuation issues and studies, but I think that they are important to note in the context of promoting wind farms in our state.

As the Vice Chair of the International Right of Way Association's Valuation Committee, I had the opportunity to moderate a session at our International Education Conference in Philadelphia this June. I invited the authors of the two most often quoted studies on the issue of wind farms and property values. Fred Beck of the Renewable Energy Policy Project (REPP) and Dr. David Tuerck of the Beacon Hill Institute at Suffolk College both

presented the findings of their respective studies. Both studies are available on the internet: www.repp.org and www.beaconhill.org.

The REPP study, The Effect of Wind Development on Local Property Values, is a 78 page report which was published in May 2003. They studied 10 areas of the country. The study surveyed assessed values and properties within 5 miles of a wind farm and showed no diminution in value to those properties due to the presence of the wind farms. Critiques have been made regarding the methodology used in that study.

The Beacon Hill Institute issued an initial 53 page report in October 2003 - Blowing in the Wind: Offshore Wind and the Cape Cod Economy and a follow up 34 page report in March 2004 - Free but Costly: An Economic Analysis of a Wind Farm in Nantucket Sound. The studies focus on Nantucket Sound in Massachusetts relative to the Cape Wind Associates proposed 130 wind turbine generator (WTG) offshore wind farm. The 2003 study projected 1) a small decline in tourism resulting in a loss of 1,173 to 2,533 jobs and 2) a decline in property values of 4.6% (10.9% for waterfront property) or \$1.35 billion and a concomitant loss in tax revenue to the area of \$8 million. Criticisms of that report have also been made.

The Tennessee Valley Authority (TVA) study on a proposed wind farm in Tennessee consisting of 13 to 16 WTGs reviewed literature on the issue. Appendix F of the study cites several studies on wind farms and their impacts. Among those are:

1. The April 1996 Danish study: Social Assessment of Windpower – Visual Effect and Noise from Windmills – Quantifying and Evaluation. It concluded that 13% of people living near windmills considered them a nuisance. Property values showed a loss in housing prices from \$2,900 (for one WTG) to \$16,000 (for a 12 unit wind farm).
2. The ongoing study in Wisconsin thought to be done in 2003. My conversation with Steve Brick of the Energy Center of Wisconsin indicated that as of this Spring their study was not finished.
3. The TVA study does mention the value of a viewshed as a percentage of the value of improved property at 8% in Fairfax, Virginia and a South Carolina analysis regarding vacant lot premiums of 147% for an ocean view, 115% for a creek or marsh view, and 39% for a golf course view.

The 2002 Strutt & Parker study of the Edinbane Windfarm on the Isle of Skye notes that the proposed 41 turbines would have a major impact on the locality. They estimated that nearby property values would decline by over \$1 million. They also note at 6.18 of their report that “In Germany, Estate Agents report diminution in values of between 20% to 30% for properties in sight of wind farms. We understand that FPD Savills have reported similar levels of depreciation for properties in Norfolk.”

The report of the Township of Lincoln Wind Turbine Moratorium Committee, Kewaunee, Wisconsin (2000 to 2002) notes that the Town of Lincoln building inspector compiled a list of home sales. The list compared the property's selling price as a function of the distance to an existing 22 WTG farm in the area. His conclusions were 1) Sales within 1 mile of the wind farm prior to the installation were 104% of the assessed values and properties selling after the wind farm introduction in the same area were at 78% of the assessed value.

Anecdotal evidence from real estate agents near Victoria, Australia indicates a 20% to 30% decrease in property values for homes near WTGs.

A court case referenced in the February 14, 2004 edition of the Daily Telegraph (UK) refers to a house near Askam in the Lakes District. The buyers were not informed of the pending installation of 4 WTGs which were 360' tall and 550 yards from their new home. No mention was made in the seller's disclosure form, despite the fact that the seller had protested the proposed wind farm installation to the local government indicating a large loss in value to their property. The court, after listening to chartered surveyors (appraisers) for both sides, concluded that the property had suffered a 20% decline in value.

The above listing is not exhaustive, but a brief mention of studies that discuss the impact on communities and nearby property values by WTGs.

Is the “jury” still out on the impact of WTGs on property value? Yes, though there do appear to be several indications that a loss in value to neighboring properties is real possibility. Can any state agency conclude that wind farms do not have the potential for causing a nuisance and devalue nearby properties and cause a “taking”? No. Whatever report the Wind Working Group comes up with, it should be informational only, include the differing opinions that are out there, not be used to usurp local land use authority in regulating WTGs just like any other land use nor to deny property owners their rights. In our quest for “energy independence” for our society in general, let us not forget the potential for economic loss to individuals as an unintended consequence. We should be prepared to compensate adjacent owners for any property rights (value) taken as a result of the introduction of wind farms.

Sincerely,

David C. Maturen, SR/WA
Certified General Real Estate Appraiser
Kalamazoo County Commissioner

Case F

“Wind turbines don’t make good neighbors : some problems of wind power in the Berkshires”

By Eleanor Tillinghast, Green Berkshires, Inc., Massachusetts, May 14, 2004

Here in the U.S., at a public meeting on Enxco’s proposal for a wind power plant in Lowell, Vermont, a realtor trying to sell a farm near the site told Mr. Zimmerman that his claim that land values won’t decrease is ‘ludicrous.’ Don Maclure said that when he tells people interested in buying the farm about the proposed project he never hears from them again.

Other realtors are similarly skeptical. “They say there will be no effect on property values. That is absolutely incorrect,” said real estate agent Roger Weaver of Kittitas County, Washington. “There is no way wind farms won’t affect property values in the Kittitas Valley. In a tremendously scenic area like the valley, the view is a major consideration in what people want.”

Mr. Weaver explained that people from Puget Sound are purchasing country lands for homes while still working in Puget Sound. “They want a beautiful place to live and retire,” he said. “Wind farms will have a real negative effect on the property values because the scenic views are a big deal, a real big deal to these people.”

As part of a study of the proposed Cape Wind [Massachusetts] project, 45 real estate professionals operating in towns around Nantucket Sound were contacted and asked about anticipated effects of the wind power project on property values.

49% of realtors expect property values within the region to fall if the Cape Wind power plant is erected.

501 home owners in the six towns that would be most affected by the Cape Wind project were also surveyed. 68% said that the turbines would worsen the view over Nantucket Sound 'slightly' or 'a lot'.

On average, they believed that Cape Wind would reduce property values by 4.0%. Those with waterfront property believed that it would lose 10.9% of its value. The study concluded that, based on the loss of property value expected by home owners, the total loss in property values resulting from the construction of Cape Wind would be \$1.35 billion, a sum substantially larger than the approximately \$800 million cost of the project itself.

As the study noted, any reduction in property values would, in turn, lead to a fall in property tax collections in the affected towns; the drop in these tax collections would be \$8 million annually. If the tax rates were raised to maintain revenue, this would shift some of the property tax burden off waterfront residents (whose property values would fall the most) and on to the (less affluent) island residents.

In the home owner survey, in response to the statement: It is important to protect an uninterrupted view of Nantucket Sound, 76% strongly agreed, 18% somewhat agreed, 3% were neutral, 2% somewhat disagreed, and 1% strongly disagreed.

It's worth noting that of the home owners surveyed, 94% did not have homes with a view of the Sound. 76% were not members of a conservation or environmental organization. Regardless, their main reasons for living in the area were the 'beauty of the region,' 'the beaches,' and 'the ocean views.'

Comment

In the various reports included in this Appendix, it is clear that individuals from rural communities within the three Continents considered in this **Appendix** are experiencing or are likely to experience economic loss through the potential or actual impact of wind turbines located close their homes.

The continual economic survival of rural communities depends both on 'old' and 'new' wealth creation. Many rural communities have enjoyed economic growth and social benefits from the influx of 'life style' families, young and old, who have brought with them wealth and economic opportunity to their chosen new communities. 'Life style' families are often seeking the pleasures of rural life and unspoilt countryside, away from the commercial and industrial development that is characteristic of our towns and cities. The devaluation of assets such as property by rural industrialisation is likely to deter further migrations to the countryside, and over time, this will inevitably reduce new economic injection into these areas.

State development-control decision-makers, who allow the industrialisation of rural settlements, with the consequent environmental pollution, are likely to trigger a slide back into rural economic deprivation as the lifetime savings of people living in these communities are eroded by the devaluation of their properties.

Peter Hadden

ACKNOWLEDGEMENTS

We would like to acknowledge the help and guidance freely given by many experts within their fields. Their generosity was invaluable. Our gratitude extends even more broadly, but special thanks to:

Dr Mariana Alves-Pereira (Biomedical Engineering)
New University of Lisbon, Portugal

Dick Bowdler, BSc, CEng, CPhys, FIOA, FCIBSE, MCI Arb
New Acoustics; Member, Dti Noise Working Group (2006 -), UK

David Brierley and the neighbours of Far Old Park Wind Turbines
Askam, Cumbria, UK

Geoffrey Cox, QC, Barrister, MP (West Devon and Torridge, Devon)

Robert Davis, Acoustician
RD Associates; Member, Dti Noise Working Group (2006 -), UK

Prof John E Ffowcs Williams, Emeritus Professor
Engineering Acoustics, Cambridge University, UK

Dr Amanda Harry, MB, ChB, PG, Dip ENT
West Hoe Surgery, Plymouth, UK

Prof Ralph V Katz, DMD, MPH, PhD, Chair
Department of Epidemiology & Health Promotion, New York University, NY, USA

Prof James Lovelock, CH, PhD, DSc
Physician, scientist, author, and founder of the Gaia Theory
Devon, UK

Dr David Manley, PhD

Nina Pierpont, MD, PhD, Paediatrician
Malone, New York, USA

Prof Hillel Pratt, PhD, Unit of Behavioural Biology
Technion-Israel Institute of Technology, Haifa, Israel

John Stewart, Chair, UK Noise Association

Frits van den Berg, Acoustic Engineer & Teacher
Science Shop for Physics, Groningen University, The Netherlands

In the early days of preparing the Human Rights Section, we were grateful for the guidance given to us by Marina Wheeler, Barrister, One Crown Office Row, Temple, London EC4; Susan Ring, Partner, Richard Buxton Solicitors, Environmental and Public Law; and John Campbell, QC. We are also appreciative for the help given to us by Eja Pedersen, who provided her publications and initial guidance.